



**KATALOQ / CATALOGUE**  
**2026**





BORULAR VƏ FİTİNLƏR  
PIPES AND FITTINGS

**P-PLAST MARKALI POLİETİLEN (HDPE) BORULAR VƏ FITİNLƏR**  
**P-PLAST BRANDED POLYETHYLENE (HDPE) PIPES AND FITTINGS**

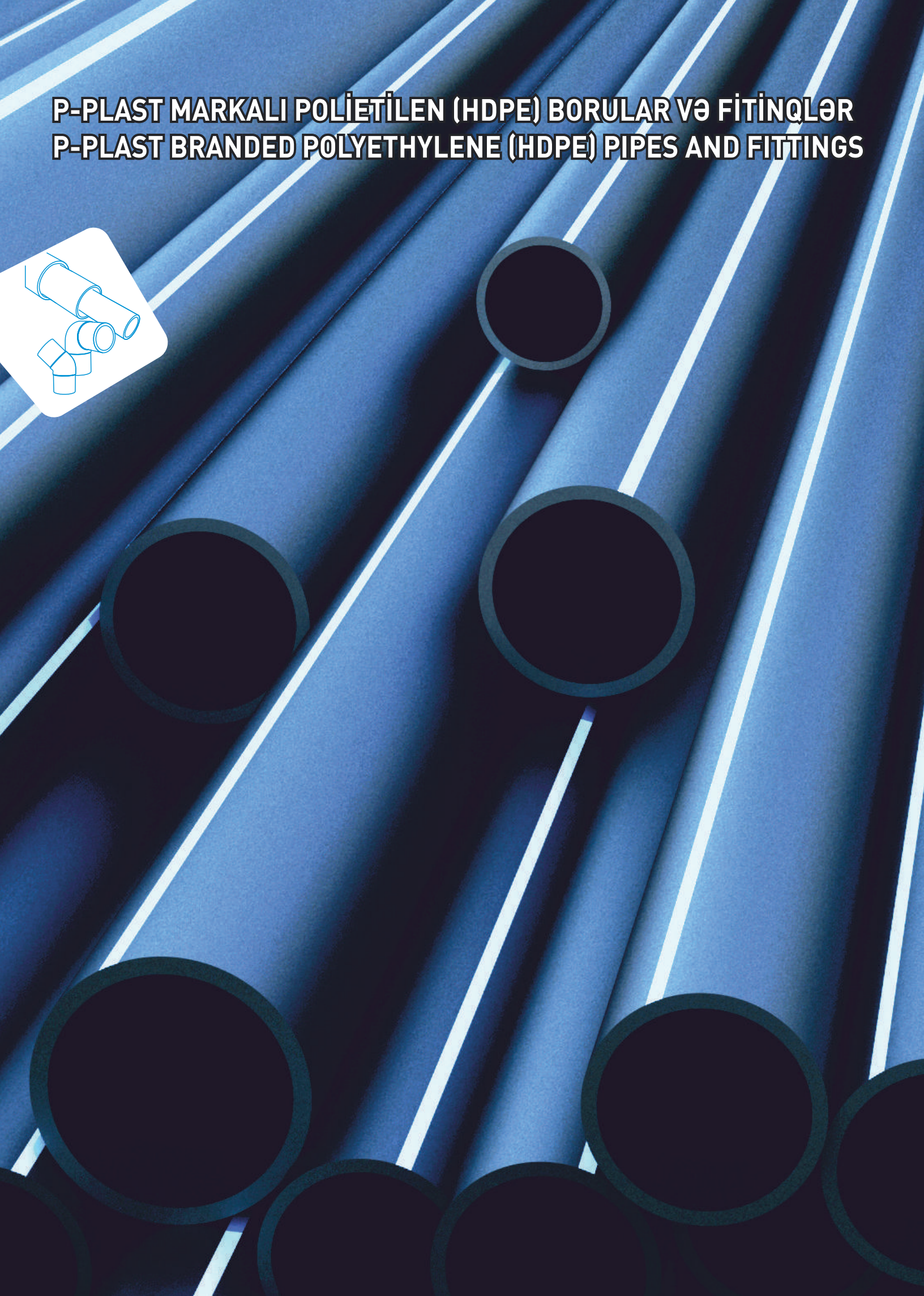
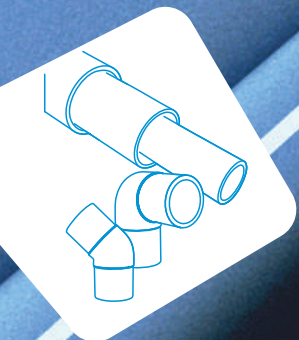

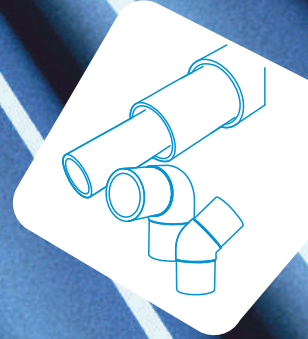

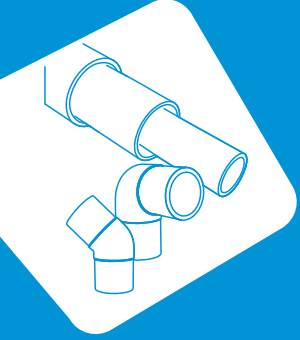

Adı/Name	Diametr/ Diameter (mm)	Təzyiq/ Pressure (ATM/PN)	Divar qalınlığı/ Wall thickness (mm)
1	PE boru/PE pipe SDR 9	20	2,3
2	PE boru/PE pipe SDR 7,4	20	3,0
3	PE boru/PE pipe SDR 11	25	2,4
4	PE boru/PE pipe SDR 9	25	3,0
5	PE boru/PE pipe SDR 13,6	32	2,4
6	PE boru/PE pipe SDR 11	32	3,0
7	PE boru/PE pipe SDR 17	40	2,4
8	PE boru/PE pipe SDR 13,6	40	3,0
9	PE boru/PE pipe SDR 11	40	3,7
10	PE boru/PE pipe SDR 9	40	4,5
11	PE boru/PE pipe SDR 21	50	2,4
12	PE boru/PE pipe SDR 17	50	3,0
13	PE boru/PE pipe SDR 13,6	50	3,7
14	PE boru/PE pipe SDR 11	50	4,6
15	PE boru/PE pipe SDR 9	50	5,6
16	PE boru/PE pipe SDR 26	63	2,5
17	PE boru/PE pipe SDR 21	63	3,0
18	PE boru/PE pipe SDR 17	63	3,8
19	PE boru/PE pipe SDR 13,6	63	4,7
20	PE boru/PE pipe SDR 11	63	5,8
21	PE boru/PE pipe SDR 9	63	7,1
22	PE boru/PE pipe SDR 26	75	2,9
23	PE boru/PE pipe SDR 21	75	3,6
24	PE boru/PE pipe SDR 17	75	4,6
25	PE boru/PE pipe SDR 13,6	75	5,6
26	PE boru/PE pipe SDR 11	75	6,8
27	PE boru/PE pipe SDR 9	75	8,4

Adı/Name	Diametr/ Diameter (mm)	Təzyiq/ Pressure (ATM/PN)	Divar qalınlığı/ Wall thickness (mm)
1	PE boru/PE pipe SDR 26	90	3,5
2	PE boru/PE pipe SDR 21	90	4,3
3	PE boru/PE pipe SDR 17	90	5,4
4	PE boru/PE pipe SDR 13,6	90	6,7
5	PE boru/PE pipe SDR 11	90	8,2
6	PE boru/PE pipe SDR 9	90	10,1
7	PE boru/PE pipe SDR 26	110	4,2
8	PE boru/PE pipe SDR 21	110	5,3
9	PE boru/PE pipe SDR 17	110	6,6
10	PE boru/PE pipe SDR 13,6	110	8,1
11	PE boru/PE pipe SDR 11	110	10,0
12	PE boru/PE pipe SDR 9	110	12,3
13	PE boru/PE pipe SDR 26	125	4,8
14	PE boru/PE pipe SDR 21	125	6,0
15	PE boru/PE pipe SDR 17	125	7,4
16	PE boru/PE pipe SDR 13,6	125	9,2
17	PE boru/PE pipe SDR 11	125	11,4
18	PE boru/PE pipe SDR 9	125	14,0
19	PE boru/PE pipe SDR 26	140	5,4
20	PE boru/PE pipe SDR 21	140	6,7
21	PE boru/PE pipe SDR 17	140	8,3
22	PE boru/PE pipe SDR 13,6	140	10,3
23	PE boru/PE pipe SDR 11	140	12,7
24	PE boru/PE pipe SDR 9	140	15,7

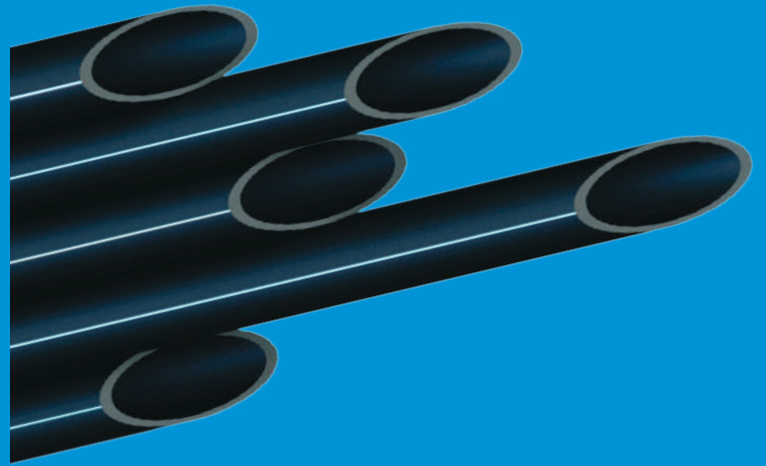

	Adı/Name	Diametr/ Diameter (mm)	Təzyiq/ Pressure (ATM/PN)	Divar qalınlığı/ Wall thickness (mm)
1	PE boru/PE pipe SDR 26	160	6	6,2
2	PE boru/PE pipe SDR 21	160	8	7,7
3	PE boru/PE pipe SDR 17	160	10	9,5
4	PE boru/PE pipe SDR 13,6	160	12,5	11,8
5	PE boru/PE pipe SDR 11	160	16	14,6
6	PE boru/PE pipe SDR 9	160	20	17,9
7	PE boru/PE pipe SDR 26	180	6	6,9
8	PE boru/PE pipe SDR 21	180	8	8,6
9	PE boru/PE pipe SDR 17	180	10	10,7
10	PE boru/PE pipe SDR 13,6	180	12,5	13,3
11	PE boru/PE pipe SDR 11	180	16	16,4
12	PE boru/PE pipe SDR 9	180	20	20,1
13	PE boru/PE pipe SDR 26	200	6	7,7
14	PE boru/PE pipe SDR 21	200	8	9,6
15	PE boru/PE pipe SDR 17	200	10	11,9
16	PE boru/PE pipe SDR 13,6	200	12,5	14,7
17	PE boru/PE pipe SDR 11	200	16	18,2
18	PE boru/PE pipe SDR 9	200	20	22,4
19	PE boru/PE pipe SDR 26	225	6	8,6
20	PE boru/PE pipe SDR 21	225	8	10,8
21	PE boru/PE pipe SDR 17	225	10	13,4
22	PE boru/PE pipe SDR 13,6	225	12,5	16,6
23	PE boru/PE pipe SDR 11	225	16	20,5
24	PE boru/PE pipe SDR 9	225	20	25,2
25	PE boru/PE pipe SDR 26	250	6	9,6
26	PE boru/PE pipe SDR 21	250	8	11,9

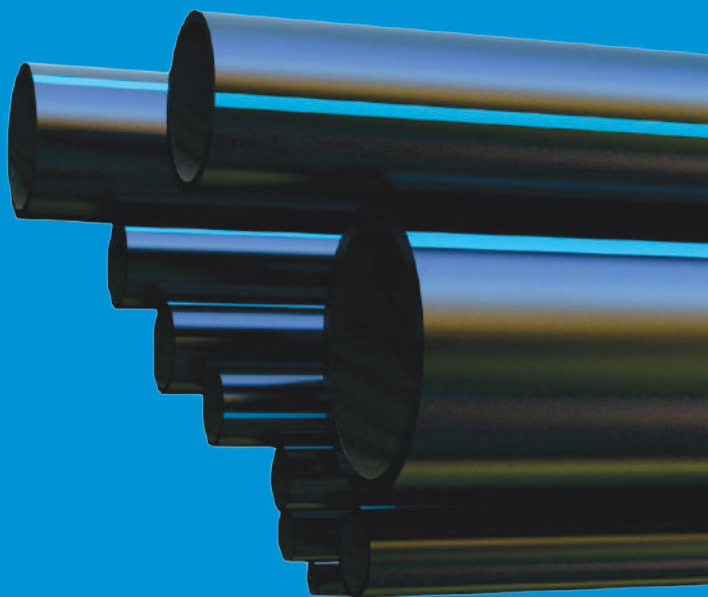
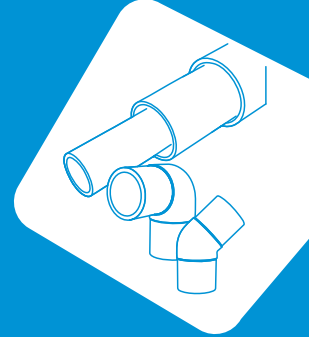
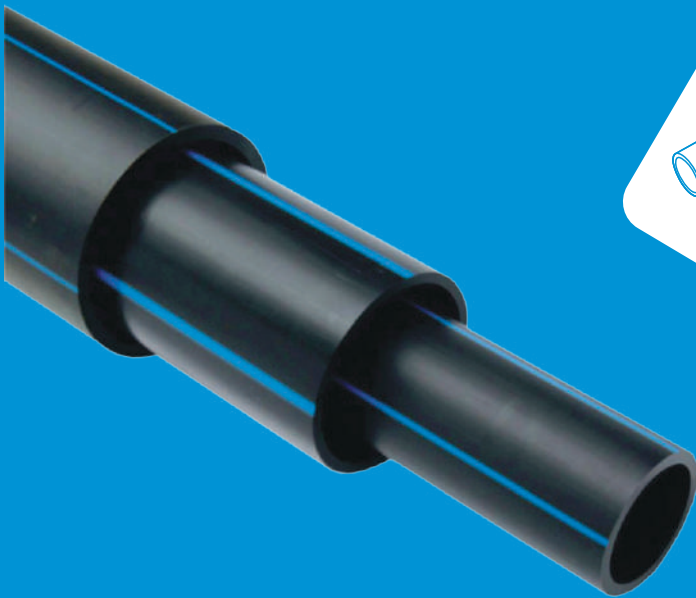

	Adı/Name	Diametr/ Diameter (mm)	Təzyiq/ Pressure (ATM/PN)	Divar qalınlığı/ Wall thickness (mm)
1	PE boru/PE pipe SDR 17	250	10	14,8
2	PE boru/PE pipe SDR 13,6	250	12,5	18,4
3	PE boru/PE pipe SDR 11	250	16	22,7
4	PE boru/PE pipe SDR 9	250	20	27,9
5	PE boru/PE pipe SDR 26	280	6	10,7
6	PE boru/PE pipe SDR 21	280	8	13,4
7	PE boru/PE pipe SDR 17	280	10	16,6
8	PE boru/PE pipe SDR 13,6	280	12,5	20,6
9	PE boru/PE pipe SDR 11	280	16	25,4
10	PE boru/PE pipe SDR 9	280	20	31,3
11	PE boru/PE pipe SDR 33	280	5	9,7
12	PE boru/PE pipe SDR 26	315	6	12,1
13	PE boru/PE pipe SDR 21	315	8	15,0
14	PE boru/PE pipe SDR 17	315	10	18,7
15	PE boru/PE pipe SDR 13,6	315	12,5	23,2
16	PE boru/PE pipe SDR 11	315	16	28,6
17	PE boru/PE pipe SDR 9	315	20	35,2
18	PE boru/PE pipe SDR 26	355	6	13,6
19	PE boru/PE pipe SDR 21	355	8	16,9
20	PE boru/PE pipe SDR 17	355	10	21,1
21	PE boru/PE pipe SDR 13,6	355	12,5	26,1

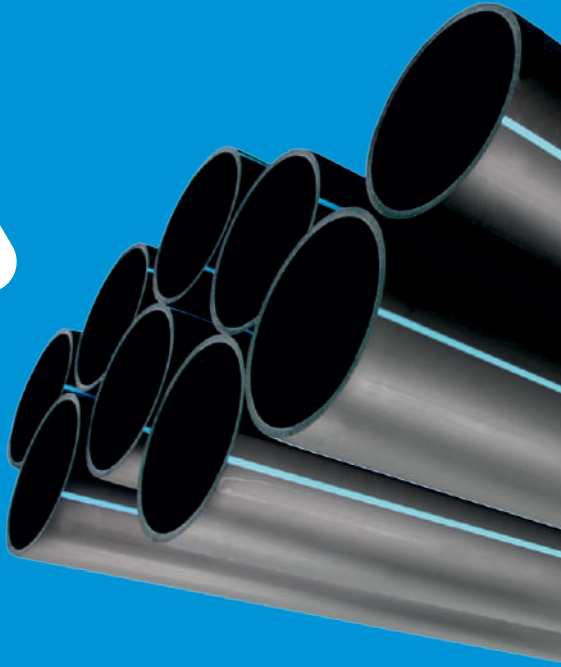
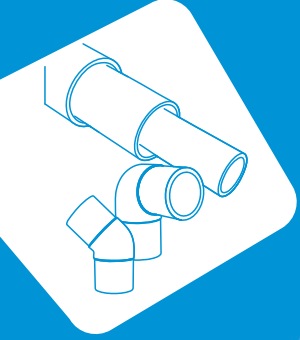

Adı/Name	Diametr/ Diameter (mm)	Təzyiq/ Pressure (ATM/PN)	Divar qalınlığı/ Wall thickness (mm)	
1	PE boru/PE pipe SDR 17	400	10	23,7
2	PE boru/PE pipe SDR 13,6	400	12,5	29,4
3	PE boru/PE pipe SDR 11	400	16	36,3
4	PE boru/PE pipe SDR 9	400	20	44,7
5	PE boru/PE pipe SDR 33	450	5	13,8
6	PE boru/PE pipe SDR 26	450	6	16,3
7	PE boru/PE pipe SDR 21	450	8	21,5
8	PE boru/PE pipe SDR 17	450	10	26,7
9	PE boru/PE pipe SDR 13,6	450	12,5	33,1
10	PE boru/PE pipe SDR 11	450	16	40,9
11	PE boru/PE pipe SDR 9	450	20	50,3
12	PE boru/PE pipe SDR 26	500	6	19,2
13	PE boru/PE pipe SDR 21	500	8	23,9
14	PE boru/PE pipe SDR 17	500	10	29,7
15	PE boru/PE pipe SDR 13,6	500	12,5	36,8
16	PE boru/PE pipe SDR 11	500	16	45,4
17	PE boru/PE pipe SDR 9	500	20	55,8
18	PE boru SDR 26	560	6	21,5
19	PE boru/PE pipe SDR 21	560	8	26,7
20	PE boru/PE pipe SDR 17	560	10	33,2
21	PE boru/PE pipe SDR 13,6	560	12,5	41,2
22	PE boru/PE pipe SDR 11	560	16	50,8

Adı/Name	Diametr/ Diameter (mm)	Təzyiq/ Pressure (ATM/PN)	Divar qalınlığı/ Wall thickness (mm)	
1	PE boru/PE pipe SDR 41	630	4	15,4
2	PE boru/PE pipe SDR 33	630	5	19,3
3	PE boru/PE pipe SDR 26	630	6	24,1
4	PE boru/PE pipe SDR 21	630	8	30,0
5	PE boru/PE pipe SDR 17	630	10	37,4
6	PE boru/PE pipe SDR 13,6	630	12,5	46,3
7	PE boru/PE pipe SDR 11	630	16	57,2
8	PE boru/PE pipe SDR 41	710	4	17,4
9	PE boru/PE pipe SDR 33	710	5	21,8
10	PE boru/PE pipe SDR 26	710	6	27,3
11	PE boru SDR 21	710	8	33,9
12	PE boru/PE pipe SDR 17	710	10	42,1
13	PE boru/PE pipe SDR 13,6	710	12,5	52,2
14	PE boru/PE pipe SDR 26	800	6	30,7
15	PE boru/PE pipe SDR 21	800	8	38,1
16	PE boru/PE pipe SDR 17	800	10	47,4
17	PE boru/PE pipe SDR 13,6	800	12,5	58,8
18	PE boru/PE pipe SDR 26	900	6	34,6
19	PE boru SDR 21	900	8	42,6
20	PE boru/PE pipe SDR 17	900	10	53,3
21	PE boru/PE pipe SDR 26	1000	6	38,4
22	PE boru/PE pipe SDR 21	1000	8	47,7
23	PE boru/PE pipe SDR 17	1000	10	59,3

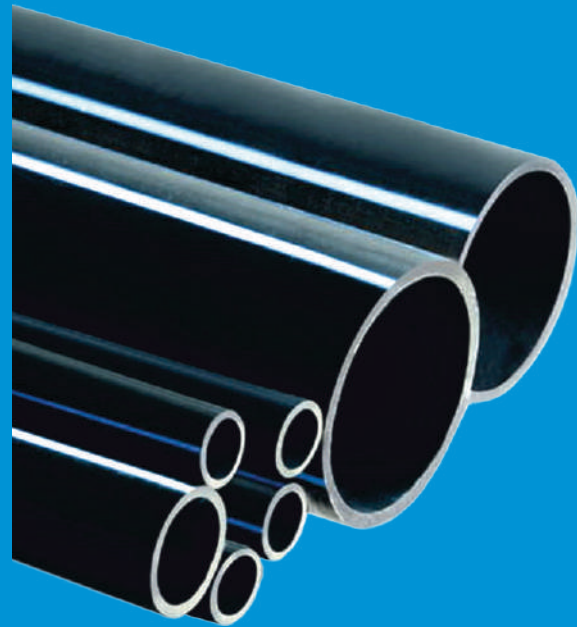



	Adı/Name	Ölçü (mm/dər) Measure (mm/deg)
1	Dirşək/Elbow SDR 17 / SDR 11	63x45°
2	Dirşək/Elbow SDR 17 / SDR 11	75x45°
3	Dirşək/Elbow SDR 17 / SDR 11	90x45°
4	Dirşək/Elbow SDR 17 / SDR 11	110x45°
5	Dirşək/Elbow SDR 17 / SDR 11	125x45°
6	Dirşək/Elbow SDR 17 / SDR 11	125x90°
7	Dirşək/Elbow SDR 17 / SDR 11	140x45°
8	Dirşək/Elbow SDR 17 / SDR 11	140x90°
9	Dirşək/Elbow SDR 17 / SDR 11	160x45°
10	Dirşək/Elbow SDR 17 / SDR 11	160x90°
11	Dirşək/Elbow SDR 17 / SDR 11	180x45°
12	Dirşək/Elbow SDR 17 / SDR 11	180x90°
13	Dirşək/Elbow SDR 17 / SDR 11	200x45°
14	Dirşək/Elbow SDR 17 / SDR 11	200x90°
15	Dirşək/Elbow SDR 17 / SDR 11	225x45°
16	Dirşək/Elbow SDR 17 / SDR 11	225x90°
17	Dirşək/Elbow SDR 17 / SDR 11	250x45°
18	Dirşək/Elbow SDR 17 / SDR 11	250x90°
19	Dirşək/Elbow SDR 17 / SDR 11	315x90°

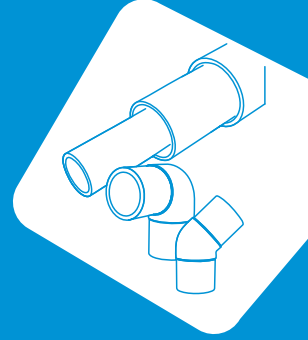

	Adı/Name	Ölçü (mm) Measure (mm)
1	Üçlük/Tee SDR 17 / SDR 11	63
2	Üçlük/Tee SDR 17 / SDR 11	75
3	Üçlük/Tee SDR 17 / SDR 11	9
4	Üçlük/Tee SDR 17 / SDR 11	110
5	Üçlük/Tee SDR 17 / SDR 11	125
6	Üçlük/Tee SDR 17 / SDR 11	140
7	Üçlük/Tee SDR 17 / SDR 11	160
8	Üçlük/Tee SDR 17 / SDR 11	180
9	Üçlük/Tee SDR 17 / SDR 11	200
10	Üçlük/Tee SDR 17 / SDR 11	225
11	Üçlük/Tee SDR 17 / SDR 11	250
12	Üçlük/Tee SDR 17 / SDR 11	280
13	Üçlük/Tee SDR 17 / SDR 11	315

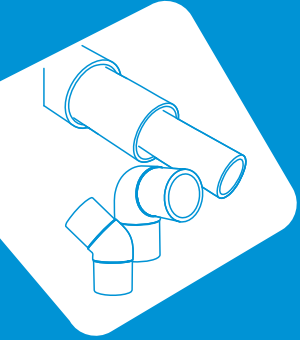

Adı/Name

Ölçü (mm)  
Measure (mm)

1	Üçlük keçid/Tee reducer SDR17/SDR11	50/32
2	Üçlük keçid/Tee reducer SDR17/SDR11	50/40
3	Üçlük keçid/Tee reducer SDR17/SDR11	63/32
4	Üçlük keçid/Tee reducer SDR17/SDR11	63/40
5	Üçlük keçid/Tee reducer SDR17/SDR11	63/50
6	Üçlük keçid/Tee reducer SDR17/SDR11	75/32
7	Üçlük keçid/Tee reducer SDR17/SDR11	75/40
8	Üçlük keçid/Tee reducer SDR17/SDR11	75/50
9	Üçlük keçid/Tee reducer SDR17/SDR11	75/63
10	Üçlük keçid/Tee reducer SDR17/SDR11	90/32
11	Üçlük keçid/Tee reducer SDR17/SDR11	90/40
12	Üçlük keçid/Tee reducer SDR17/SDR11	90/50
13	Üçlük keçid/Tee reducer SDR17/SDR11	90/63
14	Üçlük keçid/Tee reducer SDR17/SDR11	90/75
15	Üçlük keçid/Tee reducer SDR17/SDR11	110/32
16	Üçlük keçid/Tee reducer SDR17/SDR11	110/40
17	Üçlük keçid/Tee reducer SDR17/SDR11	110/50
18	Üçlük keçid/Tee reducer SDR17/SDR11	110/63
19	Üçlük keçid/Tee reducer SDR17/SDR11	110/75
20	Üçlük keçid/Tee reducer SDR17/SDR11	110/90
21	Üçlük keçid/Tee reducer SDR17/SDR11	125/50
22	Üçlük keçid/Tee reducer SDR17/SDR11	125/63
23	Üçlük keçid/Tee reducer SDR17/SDR11	125/75
24	Üçlük keçid/Tee reducer SDR17/SDR11	125/90
25	Üçlük keçid/Tee reducer SDR17/SDR11	125/110

Adı/Name

Ölçü (mm)  
Measure (mm)

1	Üçlük keçid/Tee reducer SDR17/SDR11	140/110
2	Üçlük keçid/Tee reducer SDR17/SDR11	140/125
3	Üçlük keçid/Tee reducer SDR17/SDR11	160/50
4	Üçlük keçid/Tee reducer SDR17/SDR11	160/63
5	Üçlük keçid/Tee reducer SDR17/SDR11	160/75
6	Üçlük keçid/Tee reducer SDR17/SDR11	160/90
7	Üçlük keçid/Tee reducer SDR17/SDR11	160/110
8	Üçlük keçid/Tee reducer SDR17/SDR11	160/140
9	Üçlük keçid/Tee reducer SDR17/SDR11	180/90
10	Üçlük keçid/Tee reducer SDR17/SDR11	180/110
11	Üçlük keçid/Tee reducer SDR17/SDR11	180/125
12	Üçlük keçid/Tee reducer SDR17/SDR11	180/160
13	Üçlük keçid/Tee reducer SDR17/SDR11	200/63
14	Üçlük keçid/Tee reducer SDR17/SDR11	200/90
15	Üçlük keçid/Tee reducer SDR17/SDR11	200/110
16	Üçlük keçid/Tee reducer SDR17/SDR11	200/125
17	Üçlük keçid/Tee reducer SDR17/SDR11	200/140
18	Üçlük keçid/Tee reducer SDR17/SDR11	200/160
19	Üçlük keçid/Tee reducer SDR17/SDR11	200/180
20	Üçlük keçid/Tee reducer SDR17/SDR11	225/110
21	Üçlük keçid/Tee reducer SDR17/SDR11	225/160
22	Üçlük keçid/Tee reducer SDR17/SDR11	280/110
23	Üçlük keçid/Tee reducer SDR17/SDR11	280/160
24	Üçlük keçid/Tee reducer SDR17/SDR11	560/400



	Adı/Name	Ölçü (mm) Measure (mm)
1	Keçid/Reducer SDR17/SDR11	32/20
2	Keçid/Reducer SDR17/SDR11	32/25
3	Keçid/Reducer SDR17/SDR11	50/32
4	Keçid/Reducer SDR17/SDR11	50/40
5	Keçid/Reducer SDR17/SDR11	63/20
6	Keçid/Reducer SDR17/SDR11	63/32
7	Keçid/Reducer SDR17/SDR11	63/50
8	Keçid/Reducer SDR17/SDR11	75/50
9	Keçid/Reducer SDR17/SDR11	75/63
10	Keçid/Reducer SDR17/SDR11	90/32
11	Keçid/Reducer SDR17/SDR11	90/50
12	Keçid/Reducer SDR17/SDR11	90/63
13	Keçid/Reducer SDR17/SDR11	90/75
14	Keçid/Reducer SDR17/SDR11	110/50
15	Keçid/Reducer SDR17/SDR11	110/63
16	Keçid/Reducer SDR17/SDR11	110/75
17	Keçid/Reducer SDR17/SDR11	110/90
18	Keçid/Reducer SDR17/SDR11	125/63
19	Keçid/Reducer SDR17/SDR11	125/75
20	Keçid/Reducer SDR17/SDR11	125/90
21	Keçid/Reducer SDR17/SDR11	125/110
22	Keçid/Reducer SDR17/SDR11	140/90
23	Keçid/Reducer SDR17/SDR11	140/110
24	Keçid/Reducer SDR17/SDR11	140/125
25	Keçid/Reducer SDR17/SDR11	160/90
26	Keçid/Reducer SDR17/SDR11	160/110

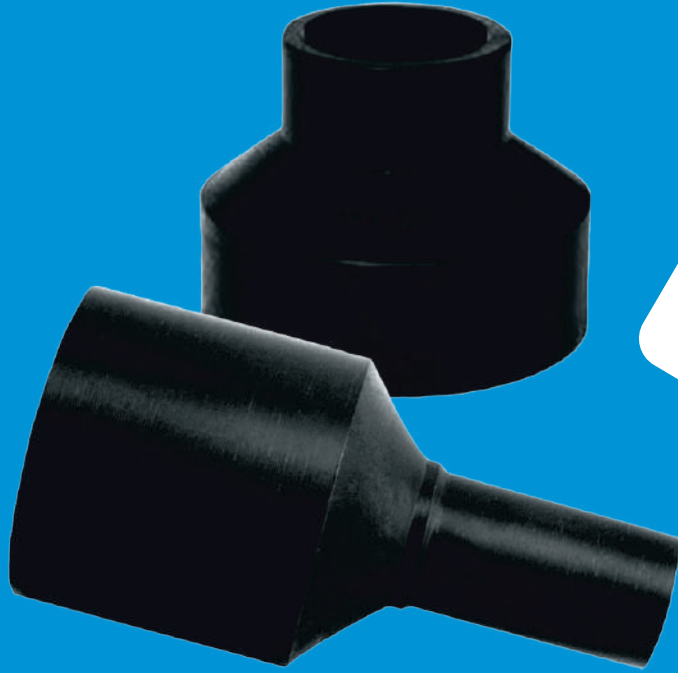

	Adı/Name	Ölçü (mm) Measure (mm)
1	Keçid/Reducer SDR17/SDR11	180/90
2	Keçid/Reducer SDR17/SDR11	180/110
3	Keçid/Reducer SDR17/SDR11	180/125
4	Keçid/Reducer SDR17/SDR11	180/140
5	Keçid/Reducer SDR17/SDR11	180/160
6	Keçid/Reducer SDR17/SDR11	200/110
7	Keçid/Reducer SDR17/SDR11	200/125
8	Keçid/Reducer SDR17/SDR11	200/160
9	Keçid/Reducer SDR17/SDR11	200/180
10	Keçid/Reducer SDR17/SDR11	225/110
11	Keçid/Reducer SDR17/SDR11	225/125
12	Keçid/Reducer SDR17/SDR11	225/140
13	Keçid/Reducer SDR17/SDR11	225/160
14	Keçid/Reducer SDR17/SDR11	225/180
15	Keçid/Reducer SDR17/SDR11	225/200
16	Keçid/Reducer SDR17/SDR11	250/110
17	Keçid/Reducer SDR17/SDR11	250/125
18	Keçid/Reducer SDR17/SDR11	250/160
19	Keçid/Reducer SDR17/SDR11	250/180
20	Keçid/Reducer SDR17/SDR11	250/200
21	Keçid/Reducer SDR17/SDR11	250/225
22	Keçid/Reducer SDR17/SDR11	280/125
23	Keçid/Reducer SDR17/SDR11	280/160
24	Keçid/Reducer SDR17/SDR11	280/200
25	Keçid/Reducer SDR17/SDR11	280/250

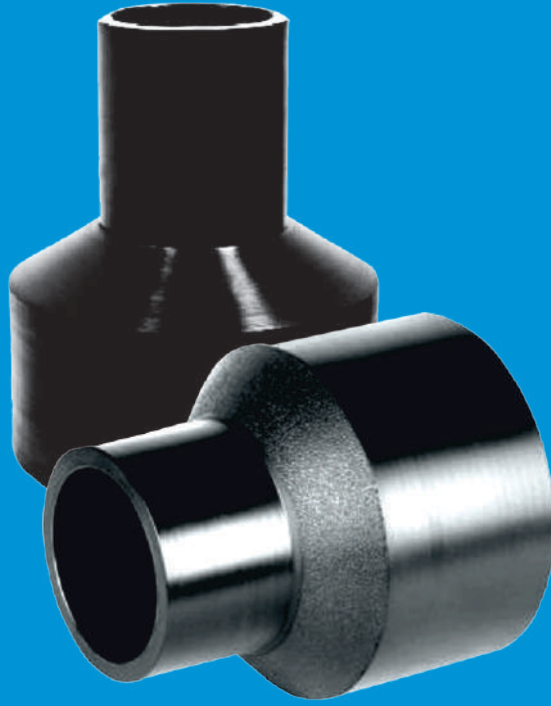
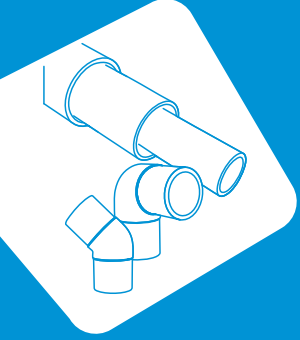

Adı/Name	Ölçü (mm) Measure (mm)	
1	Keçid/Reducer SDR17/SDR11	315/200
2	Keçid/Reducer SDR17/SDR11	315/225
3	Keçid/Reducer SDR17/SDR11	315/250
4	Keçid/Reducer SDR17/SDR11	315/280
5	Keçid/Reducer SDR17/SDR11	355/250
6	Keçid/Reducer SDR17/SDR11	355/280
7	Keçid/Reducer SDR17/SDR11	355/315
8	Keçid/Reducer SDR17/SDR11	400/250
9	Keçid/Reducer SDR17/SDR11	400/315
10	Keçid/Reducer SDR17/SDR11	400/355
11	Keçid/Reducer SDR17/SDR11	450/250
12	Keçid/Reducer SDR17/SDR11	450/280
13	Keçid/Reducer SDR17/SDR11	450/355
14	Keçid/Reducer SDR17/SDR11	450/400
15	Keçid/Reducer SDR17/SDR11	500/315
16	Keçid/Reducer SDR17/SDR11	500/355
17	Keçid/Reducer SDR17/SDR11	500/400
18	Keçid/Reducer SDR17/SDR11	500/450
19	Keçid/Reducer SDR17/SDR11	560/355
20	Keçid/Reducer SDR17/SDR11	560/400
21	Keçid/Reducer SDR17/SDR11	560/450
22	Keçid/Reducer SDR17/SDR11	560/500
23	Keçid/Reducer SDR17/SDR11	630/500
24	Keçid/Reducer SDR17/SDR11	630/560
25	Keçid/Reducer SDR17/SDR11	710/560
26	Keçid/Reducer SDR17/SDR11	710/630
27	Keçid/Reducer SDR17/SDR11	800/630

Adı/Name	Ölçü (mm) Measure (mm)	
1	PE-Metal keçid/PE-Metal reducer SDR17/SDR11	20-1/2"
2	PE-Metal keçid/PE-Metal reducer SDR17/SDR11	25-3/4"
3	PE-Metal keçid/PE-Metal reducer SDR17/SDR11	32-1"
4	PE-Metal keçid/PE-Metal reducer SDR17/SDR11	40-1 1/4"
5	PE-Metal keçid/PE-Metal reducer SDR17/SDR11	50-1 1/2"
6	PE-Metal keçid/PE-Metal reducer SDR17/SDR11	63-2"
7	PE-Metal keçid/PE-Metal reducer SDR17/SDR11	90-3"
8	PE-Metal keçid/PE-Metal reducer SDR17/SDR11	110-4"
9	PE-Metal keçid/PE-Metal reducer SDR17/SDR11	125-4"
10	PE-Metal keçid/PE-Metal reducer SDR17/SDR11	160-6"
11	PE-Metal keçid/PE-Metal reducer SDR17/SDR11	180-6"
12	PE-Metal keçid/PE-Metal reducer SDR17/SDR11	200-8"
13	PE-Metal keçid/PE-Metal reducer SDR17/SDR11	225-8"
14	PE-Metal keçid/PE-Metal reducer SDR17/SDR11	250-10"
15	PE-Metal keçid/PE-Metal reducer SDR17/SDR11	280-10"
16	PE-Metal keçid/PE-Metal reducer SDR17/SDR11	315-12"
17	PE-Metal keçid/PE-Metal reducer SDR17/SDR11	355-14"
18	PE-Metal keçid/PE-Metal reducer SDR17/SDR11	400-16"
19	PE-Metal keçid/PE-Metal reducer SDR17/SDR11	450-18"
20	PE-Metal keçid/PE-Metal reducer SDR17/SDR11	500-20"



	Adı/Name	Ölçü (mm) Measure (mm)
1	Ef servis te / Ef service tee SDR11	40/20
2	Ef servis te / Ef service tee SDR11	40/25
3	Ef servis te / Ef service tee SDR11	40/32
4	Ef servis te / Ef service tee SDR11	50/20
5	Ef servis te / Ef service tee SDR11	50/25
6	Ef servis te / Ef service tee SDR11	50/32
7	Ef servis te / Ef service tee SDR11	50/40
8	Ef servis te / Ef service tee SDR11	63/20
9	Ef servis te / Ef service tee SDR11	63/25
10	Ef servis te / Ef service tee SDR11	63/32
11	Ef servis te / Ef service tee SDR11	63/40
12	Ef servis te / Ef service tee SDR11	90/32
13	Ef servis te / Ef service tee SDR11	90/40
14	Ef servis te / Ef service tee SDR11	90/50
15	Ef servis te / Ef service tee SDR11	90/63
16	Ef servis te / Ef service tee SDR11	110/20
17	Ef servis te / Ef service tee SDR11	110/25
18	Ef servis te / Ef service tee SDR11	110/32
19	Ef servis te / Ef service tee SDR11	110/40
20	Ef servis te / Ef service tee SDR11	110/50
21	Ef servis te / Ef service tee SDR11	110/63
22	Ef servis te / Ef service tee SDR11	125/20
23	Ef servis te / Ef service tee SDR11	125/25
24	Ef servis te / Ef service tee SDR11	125/32
25	Ef servis te / Ef service tee SDR11	125/40
26	Ef servis te / Ef service tee SDR11	125/50

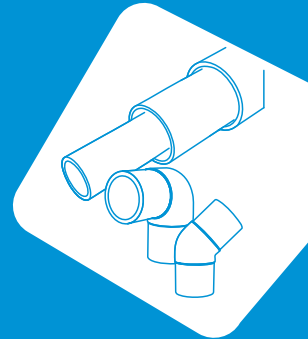

	Adı/Name	Ölçü (mm) Measure (mm)
1	Ef servis te / Ef service tee SDR11	125/63
2	Ef servis te / Ef service tee SDR11	140/20
3	Ef servis te / Ef service tee SDR11	140/25
4	Ef servis te / Ef service tee SDR11	140/32
5	Ef servis te / Ef service tee SDR11	140/40
6	Ef servis te / Ef service tee SDR11	140/50
7	Ef servis te / Ef service tee SDR11	140/63
8	Ef servis te / Ef service tee SDR11	160/20
9	Ef servis te / Ef service tee SDR11	160/25
10	Ef servis te / Ef service tee SDR11	160/32
11	Ef servis te / Ef service tee SDR11	160/40
12	Ef servis te / Ef service tee SDR11	160/50
13	Ef servis te / Ef service tee SDR11	160/63
14	Ef servis te / Ef service tee SDR11	180/20
15	Ef servis te / Ef service tee SDR11	180/25
16	Ef servis te / Ef service tee SDR11	180/32
17	Ef servis te / Ef service tee SDR11	180/40
18	Ef servis te / Ef service tee SDR11	180/50
19	Ef servis te / Ef service tee SDR11	180/63
20	Ef servis te / Ef service tee SDR11	200/20
21	Ef servis te / Ef service tee SDR11	200/25
22	Ef servis te / Ef service tee SDR11	200/32
23	Ef servis te / Ef service tee SDR11	200/40
24	Ef servis te / Ef service tee SDR11	200/50
25	Ef servis te / Ef service tee SDR11	200/63

**P-PLAST MARKALI POLİETİLEN (HDPE) KORUGE BORULAR VƏ FİTİNLƏR**  
**P-PLAST BRANDED POLYETHYLENE (HDPE) CORRUGATED PIPES AND FITTINGS**

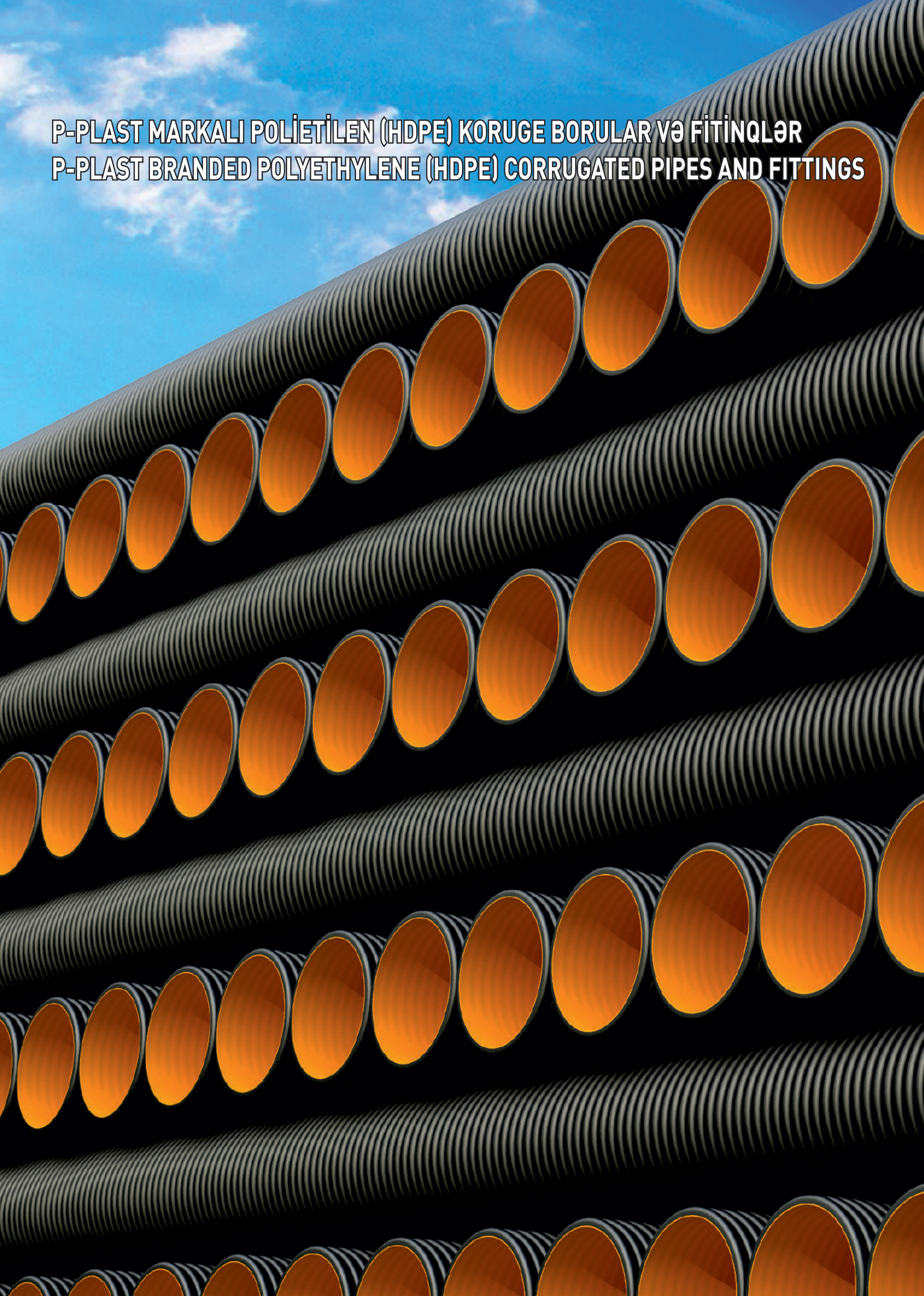

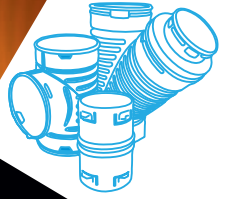

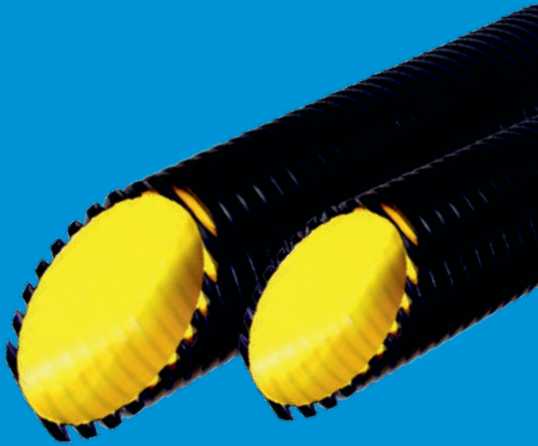
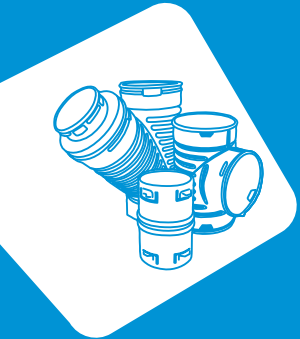

	Adı Name	Diametr/ Diameter (mm)	Xarici müqaviməti Ring rigidity
1	PE koruge boru/PE corrugated pipe	150	Sn4/Sn8
2	PE koruge boru/PE corrugated pipe	200	Sn4/Sn8
3	PE koruge boru/PE corrugated pipe	300	Sn4/Sn8
4	PE koruge boru/PE corrugated pipe	400	Sn4/Sn8
5	PE koruge boru/PE corrugated pipe	500	Sn4/Sn8
6	PE koruge boru/PE corrugated pipe	600	Sn4/Sn8
7	PE koruge boru/PE corrugated pipe	800	Sn4/Sn8
8	PE koruge boru/PE corrugated pipe	1000	Sn4/Sn8

	Adı Name	Ölçü (mm/dər) Measure (mm/deg)
1	Koruge üçlük/Corrugated tee	160x160x90°
2	Koruge üçlük/Corrugated tee	160x160x45°
3	Koruge üçlük/Corrugated tee	200x200x90°
4	Koruge üçlük/Corrugated tee	200x200x45°
5	Koruge üçlük/Corrugated tee	300x300x90°
6	Koruge üçlük/Corrugated tee	300x300x45°
7	Koruge üçlük/Corrugated tee	200x160x90°
8	Koruge üçlük/Corrugated tee	200x160x45°
9	Koruge üçlük/Corrugated tee	300x160x90°
10	Koruge üçlük/Corrugated tee	300x160x45°
11	Koruge üçlük/Corrugated tee	300x200x90°
12	Koruge üçlük/Corrugated tee	300x200x45°



	Adı Name	Ölçü (mm/dər) Measure (mm/deg)
1	Koruge dirsək/Corrugated elbow	160x90°
2	Koruge dirsək/Corrugated elbow	160x45°
3	Koruge dirsək/Corrugated elbow	200x90°
4	Koruge dirsək/Corrugated elbow	200x45°
5	Koruge dirsək/Corrugated elbow	300x90°
6	Koruge dirsək/Corrugated elbow	300x45°
7	Koruge dirsək/Corrugated elbow	400x90°
8	Koruge dirsək/Corrugated elbow	500x90°
9	Koruge dirsək/Corrugated elbow	500x45°
10	Koruge keçid/Corrugated reducer	200/160
11	Koruge keçid/Corrugated reducer	300/160
12	Koruge keçid/Corrugated reducer	400/160
13	Koruge keçid/Corrugated reducer	500/160
14	Koruge keçid/Corrugated reducer	300/200
15	Koruge keçid/Corrugated reducer	400/200
16	Koruge keçid/Corrugated reducer	500/200
17	Koruge keçid/Corrugated reducer	400/300
18	Koruge keçid/Corrugated reducer	500/300
19	Koruge keçid/Corrugated reducer	500/400

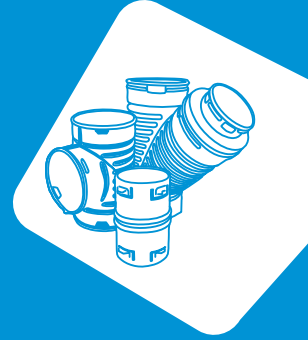

	Adı Name	Ölçü (mm) Measure (mm)
1	Koruge qapaq/Corrugated end cap	200
2	Koruge qapaq/Corrugated end cap	300
3	Koruge qapaq/Corrugated end cap	400
4	Koruge qapaq/Corrugated end cap	500
5	Koruge qapaq/Corrugated end cap	160
6	Koruge qapaq/Corrugated end cap	200
7	Koruge qapaq/Corrugated end cap	300
8	Koruge qapaq/Corrugated end cap	400
9	Koruge qapaq/Corrugated end cap	500
10	Korugedən PVC-yə keçid/Corrugated reducer to PVC	160/110
11	Korugedən PVC-yə keçid/Corrugated reducer to PVC	200/110
12	Korugedən PVC-yə keçid/Corrugated reducer to PVC	200/160
13	Korugedən PVC-yə keçid/Corrugated reducer to PVC	300/160
14	Korugedən PVC-yə keçid/Corrugated reducer to PVC	300/200
15	Korugedən PVC-yə keçid/Corrugated reducer to PVC	300/250

**P-PLAST MARKALI PVC TULLANTI SU BORULARI VƏ FITİŃQLƏRİ**  
**P-PLAST BRANDED PVC SEWERAGE WATER PIPES AND FITTINGS**



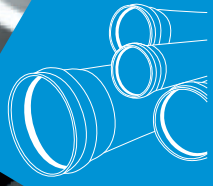

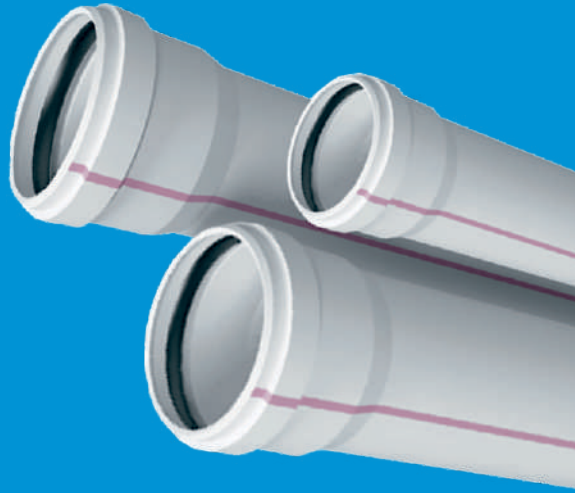
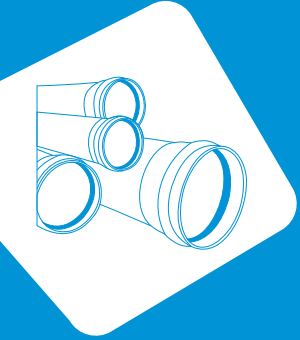

	Ölçü (diametr x uzunluq) Measure (diameter x length) mm	Divar qalınlığı/ Wall thickness (mm)
1	50x250	2,2
2	50x500	2,2
3	50x1000	2,2
4	50x2000	2,2
5	50x3000	2,2
6	75x150	2,2
7	75x250	2,2
8	75x500	2,2
9	75x1000	2,2
10	75x2000	2,2
11	75x3000	2,2
12	110x250	2,2
13	110x500	2,2
14	110x1000	2,2
15	110x2000	2,2
16	110x3000	2,2
17	110x6000	2,2

	Ölçü (diametr x uzunluq) Measure (diameter x length) mm	Divar qalınlığı/ Wall thickness (mm)
1	50x150	3,2
2	50x250	3,2
3	50x500	3,2
4	50x1000	3,2
5	50x2000	3,2
6	50x3000	3,2
7	75x150	3,2
8	75x250	3,2
9	75x500	3,2
10	75x1000	3,2
11	75x2000	3,2
12	75x3000	3,2
13	110x250	3,2
14	110x500	3,2
15	110x1000	3,2
16	110x2000	3,2
17	110x3000	3,2
18	110x6000	3,2
19	125x6000	3,2
20	160x6000	3,2
21	160x6000	4,0
22	160x6000	4,9
23	200x6000	4,9
24	250x6000	6,2
25	315x6000	6,2
26	355x6000	7,0
27	400x6000	7,9
28	500x6000	9,8
29	500x6000	12,3



	Adı Name	Ölçü (mm/dəər) Measure (mm/deg)	Divar qalınlığı/ Wall thickness (mm)
1	PVC üçlük/PVC tee	160x160x90°	3,2
2	PVC üçlük/PVC tee	160x160x45°	3,2
3	PVC üçlük/PVC tee	160x125x90°	3,2
4	PVC üçlük/PVC tee	160x125x45°	3,2
5	PVC üçlük/PVC tee	160x110x90°	3,2
6	PVC üçlük/PVC tee	160x110x45°	3,2
7	PVC üçlük/PVC tee	125x125x90°	3,2
8	PVC üçlük/PVC tee	125x125x45°	3,2
9	PVC üçlük/PVC tee	125x110x90°	3,2
10	PVC üçlük/PVC tee	125x110x45°	3,2
11	PVC üçlük/PVC tee	110x110x90°	3,2
12	PVC üçlük/PVC tee	110x110x45°	3,2
13	PVC üçlük/PVC tee	110x75x90°	3,2
14	PVC üçlük/PVC tee	110x75x45°	3,2
15	PVC üçlük/PVC tee	110x50x90°	3,2
16	PVC üçlük/PVC tee	110x50x45°	3,2
17	PVC üçlük/PVC tee	75x75x90°	3,2
18	PVC üçlük/PVC tee	75x75x45°	3,2
19	PVC üçlük/PVC tee	75x50x90°	3,2
20	PVC üçlük/PVC tee	75x50x45°	3,2
21	PVC üçlük/PVC tee	50x50x90°	3,2
22	PVC üçlük/PVC tee	50x50x45°	3,2

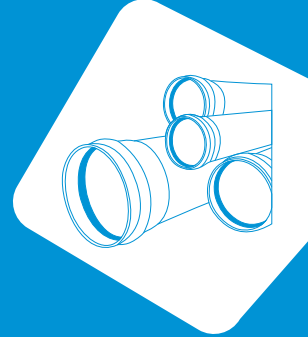

	Adı Name	Ölçü (mm/dəər) Measure (mm/deg)	Divar qalınlığı/ Wall thickness (mm)
1	Dirşək/Elbow	200x90°	3,2
2	Dirşək/Elbow	200x45°	3,2
3	Dirşək/Elbow	160x90°	3,2
4	Dirşək/Elbow	160x45°	3,2
5	Dirşək/Elbow	125x90°	3,2
6	Dirşək/Elbow	125x45°	3,2
7	Dirşək/Elbow	110x90°	3,2
8	Dirşək/Elbow	110x45°	3,2
9	Dirşək/Elbow	75x90°	3,2
10	Dirşək/Elbow	75x45°	3,2
11	Dirşək/Elbow	50x90°	3,2
12	Dirşək/Elbow	50x45°	3,2
13	Mufta/Coupler	160	3,2
14	Mufta/Coupler	125	3,2
15	Mufta/Coupler	110	3,2
16	Mufta/Coupler	75	3,2
17	Mufta/Coupler	60	3,2
18	Keçid/Reducer	200/110	3,2
19	Keçid/Reducer	160/110	3,2
20	Keçid/Reducer	125/110	3,2
21	Keçid/Reducer	110/50	3,2
22	Keçid/Reducer	110/75	3,2
23	Keçid/Reducer	75/50	3,2
24	Qapaq/End cap	160	3,2
25	Qapaq/End cap	125	3,2
26	Qapaq/End cap	110	3,2
27	Qapaq/End cap	75	3,2
28	Qapaq/End cap	50	3,2

**P-PLAST MARKALI U-PVC TƏZYİQLİ SU BORULARI VƏ FİTİNLƏRİ**  
**P-PLAST BRANDED U-PVC PRESSURE WATER PIPES AND FITTINGS**

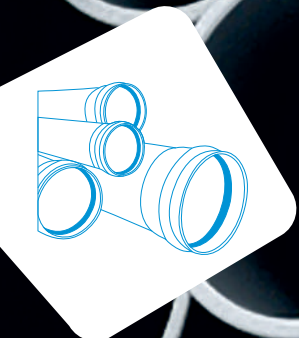

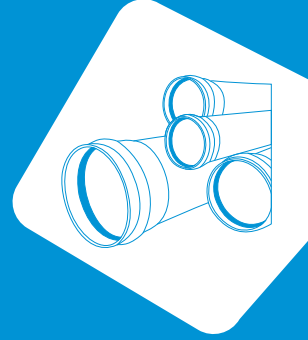

	Diametr Diameter (mm)	Divar qalınlığı/ Wall thickness (mm)	Təzyiq Pressure ATM / PN
1	20	2,9	20
2	25	2,9	20
3	32	2,9	20
4	40	3,7	20
5	50	3,0	12,5
6	50	3,7	16
7	50	4,6	20
8	63	3,0	10
9	63	3,8	12,5
10	63	4,7	16
11	63	5,8	20
12	75	3,6	10
13	75	4,5	12,5
14	75	5,6	16
15	75	6,8	20
16	90	4,3	10
17	110	3,2	7,5
18	110	3,4	8
19	110	4,2	10
20	110	5,3	12,5
21	110	6,6	16
22	110	8,1	20
23	125	4,8	10
24	160	4,0	6
25	160	4,7	7,5
26	160	4,9	8

	Diametr Diameter (mm)	Divar qalınlığı/ Wall thickness (mm)	Təzyiq Pressure ATM/PN
1	160	6,2	10,0
2	160	7,7	12,5
3	160	9,5	16,0
4	200	4,9	6,0
5	200	6,2	7,5
6	200	7,7	8,0
7	200	9,6	10,0
8	200	11,9	12,5
9	250	6,2	6,0
10	250	7,3	7,5
11	250	7,7	8,0
12	250	9,6	10,0
13	250	11,9	12,5
14	250	14,8	16,0
15	315	7,7	6,0
16	315	9,8	8,0
17	315	12,1	10,0
18	355	8,7	6,0
19	355	10,9	8,0
20	355	13,6	10,0
21	400	9,8	6,0
22	400	12,3	8,0
23	400	15,3	10,0
24	500	14,6	6,0
25	500	19,1	8,0

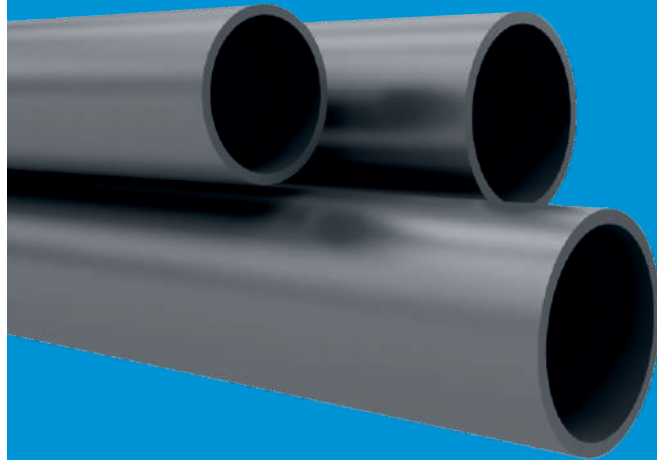

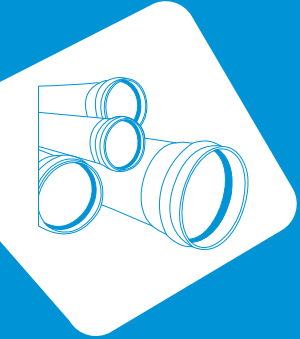

	Adı Name	Ölçü (mm/dər) Measure (mm/deg)
1	Dirşək/Elbow	110x90°
2	Dirşək/Elbow	90x90°
3	Dirşək/Elbow	75x90°
4	Dirşək/Elbow	63x90°
5	Dirşək/Elbow	50x90°
6	Dirşək/Elbow	40x90°
7	Dirşək/Elbow	32x90°
8	Dirşək/Elbow	25x90°
9	Dirşək/Elbow	20x90°
10	Dirşək/Elbow	110x45°
11	Dirşək/Elbow	90x45°
12	Dirşək/Elbow	75x45°
13	Dirşək/Elbow	63x45°
14	Dirşək/Elbow	50x45°
15	Dirşək/Elbow	40x45°
16	Dirşək/Elbow	32x45°
17	Dirşək/Elbow	25x45°
18	Dirşək/Elbow	20x45°



	Adı Name	Diametr Diameter (mm)
1	Mufta/Coupler	Ø 20
2	Mufta/Coupler	Ø 25
3	Mufta/Coupler	Ø 32
4	Mufta/Coupler	Ø 50
5	Mufta/Coupler	Ø 63
6	Mufta/Coupler	Ø 75
7	Mufta/Coupler	Ø 110
8	Mufta/Coupler	Ø 125
9	Mufta/Coupler	Ø 160
10	Mufta/Coupler	Ø 200
11	Üçlük/Tee	200x200x90°
12	Üçlük/Tee	160x160x90°
13	Üçlük/Tee	125x125x90°
14	Üçlük/Tee	100x100x90°
15	Üçlük/Tee	90x90x90°
16	Üçlük/Tee	75x75x90°
17	Üçlük/Tee	63x63x90°
18	Üçlük/Tee	50x50x90°
19	Üçlük/Tee	40x40x90°
20	Üçlük/Tee	32x32x90°
21	Üçlük/Tee	25x25x90°
22	Üçlük/Tee	20x20x90°

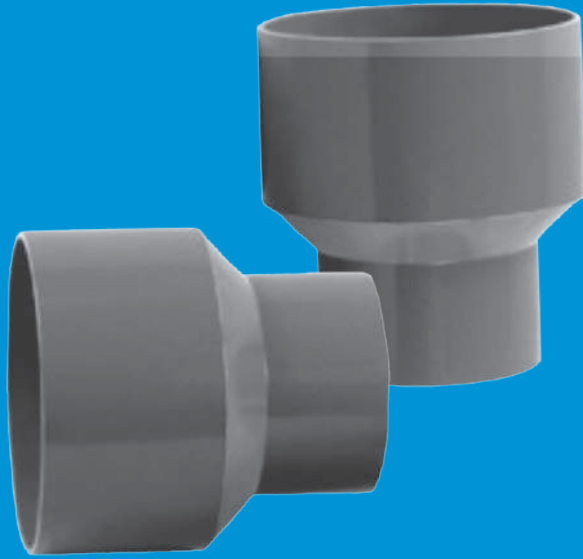

	Adı Name	Ölçüsü Measure (mm)
1	Keçid/Reducer	200/160
2	Keçid/Reducer	160/125
3	Keçid/Reducer	125/110
4	Keçid/Reducer	110/90
5	Keçid/Reducer	110/75
6	Keçid/Reducer	110/63
7	Keçid/Reducer	90/75
8	Keçid/Reducer	90/63
9	Keçid/Reducer	75/63
10	Keçid/Reducer	75/50
11	Keçid/Reducer	75/40
12	Keçid/Reducer	63/50
13	Keçid/Reducer	63/40
14	Keçid/Reducer	63/32
15	Keçid/Reducer	63/20
16	Keçid/Reducer	50/20
17	Keçid/Reducer	50/25
18	Keçid/Reducer	50/32
19	Keçid/Reducer	50/40
20	Keçid/Reducer	32/25
21	Keçid/Reducer	32/20
22	Keçid/Reducer	25/20
23	Keçid/Reducer	40/32

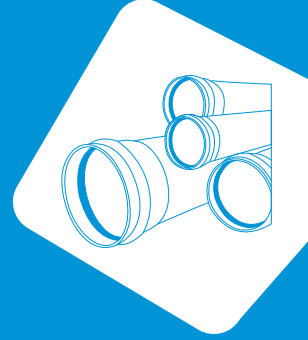

	Adı Name	Ölçüsü Measure (mm)
1	İç diş adapter/Inner thread adapter	110
2	İç diş adapter/Inner thread adapter	90
3	İç diş adapter/Inner thread adapter	75
4	İç diş adapter/Inner thread adapter	63
5	İç diş adapter/Inner thread adapter	50
6	İç diş adapter/Inner thread adapter	40
7	Çöl diş adapter/Outer thread adapter	110
8	Çöl diş adapter/Outer thread adapter	90
9	Çöl diş adapter/Outer thread adapter	75
10	Çöl diş adapter/Outer thread adapter	63
11	Çöl diş adapter/Outer thread adapter	50
12	Çöl diş adapter/Outer thread adapter	40



# POLİPROPİLEN (PPRC) SU BORULARI VƏ FİTİNLƏRİ

## POLYPROPYLENE (PPRC) WATER PIPES AND FITTINGS

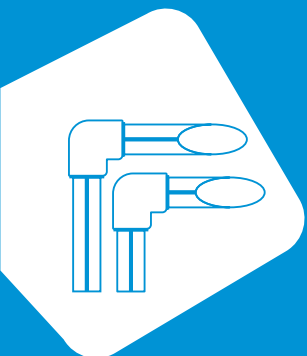

	Diametr Diameter (mm)	Divar qalınlığı/ Wall thickness (mm)	Təzyiq Pressure (ATM/PN)
1	20	3,4	20
2	25	4,2	20
3	32	5,4	20
4	40	6,7	20
5	50	8,4	20
6	63	10,5	20
7	20	2,8	16
8	25	3,5	16
9	32	4,5	16
10	40	5,6	16
11	50	6,9	16
12	63	8,7	16
13	20	1,9	10
14	25	2,3	10
15	32	2,9	10
16	40	3,7	10
17	50	4,6	10
18	63	5,8	10



GEOMEMBRAN  
GEOMEMBRANE

# PVC GEOMEMBRAN / PVC GEOMEMBRANE

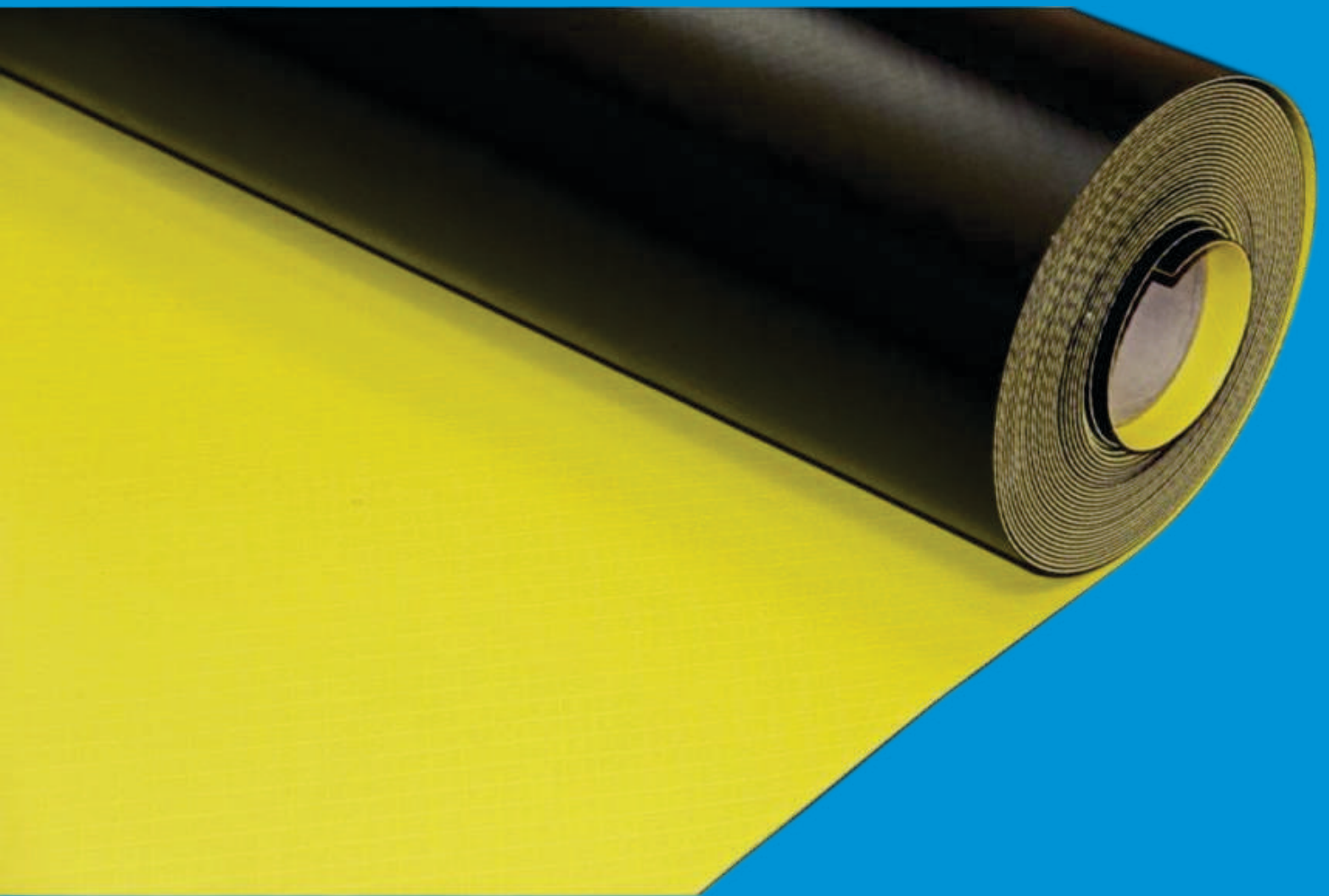

## HDPE GEOMEMBRAN / HDPE GEOMEMBRANE

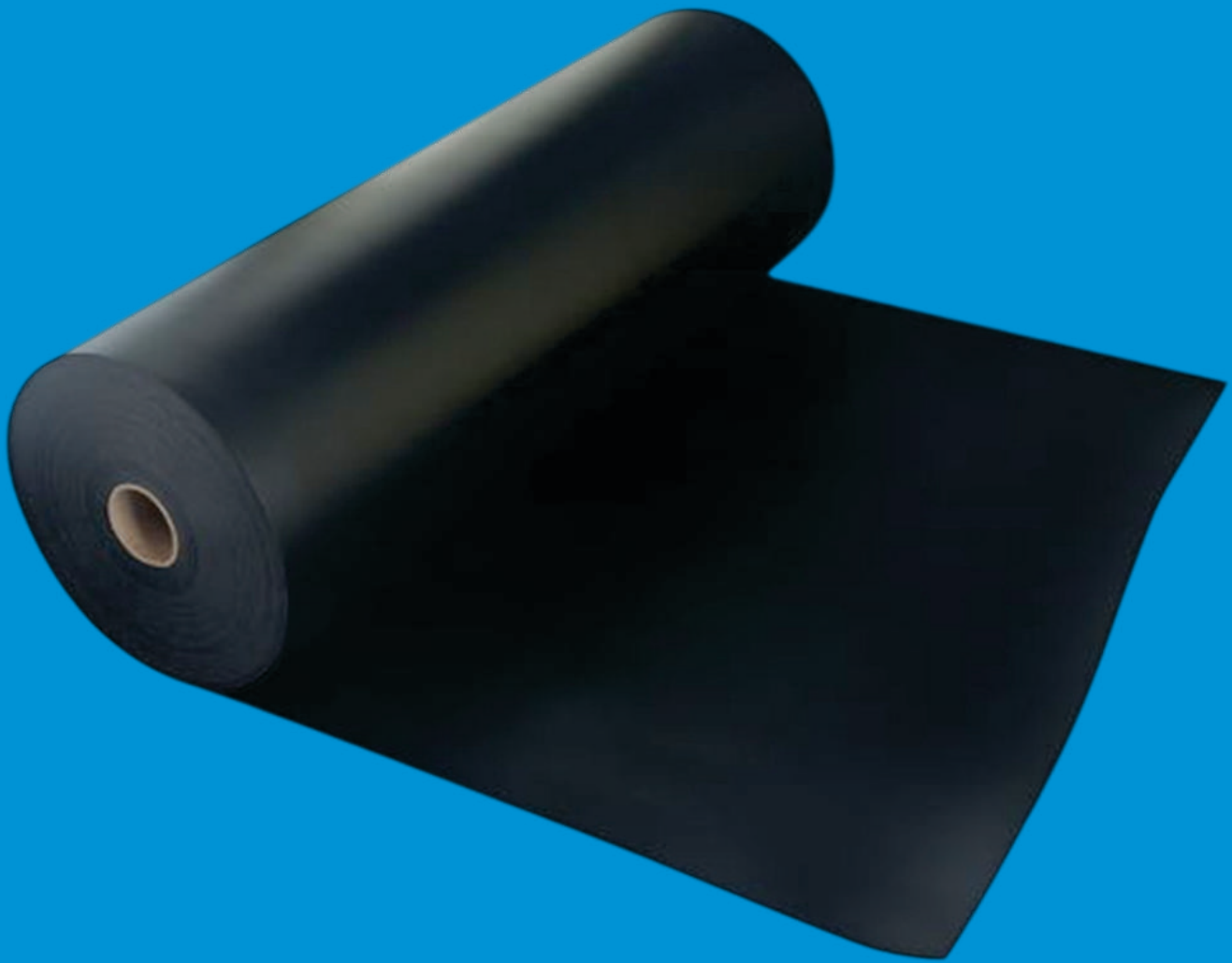

## HDPE TEKSTURALI GEOMEMBRAN / HDPE TEXTURED GEOMEMBRANE

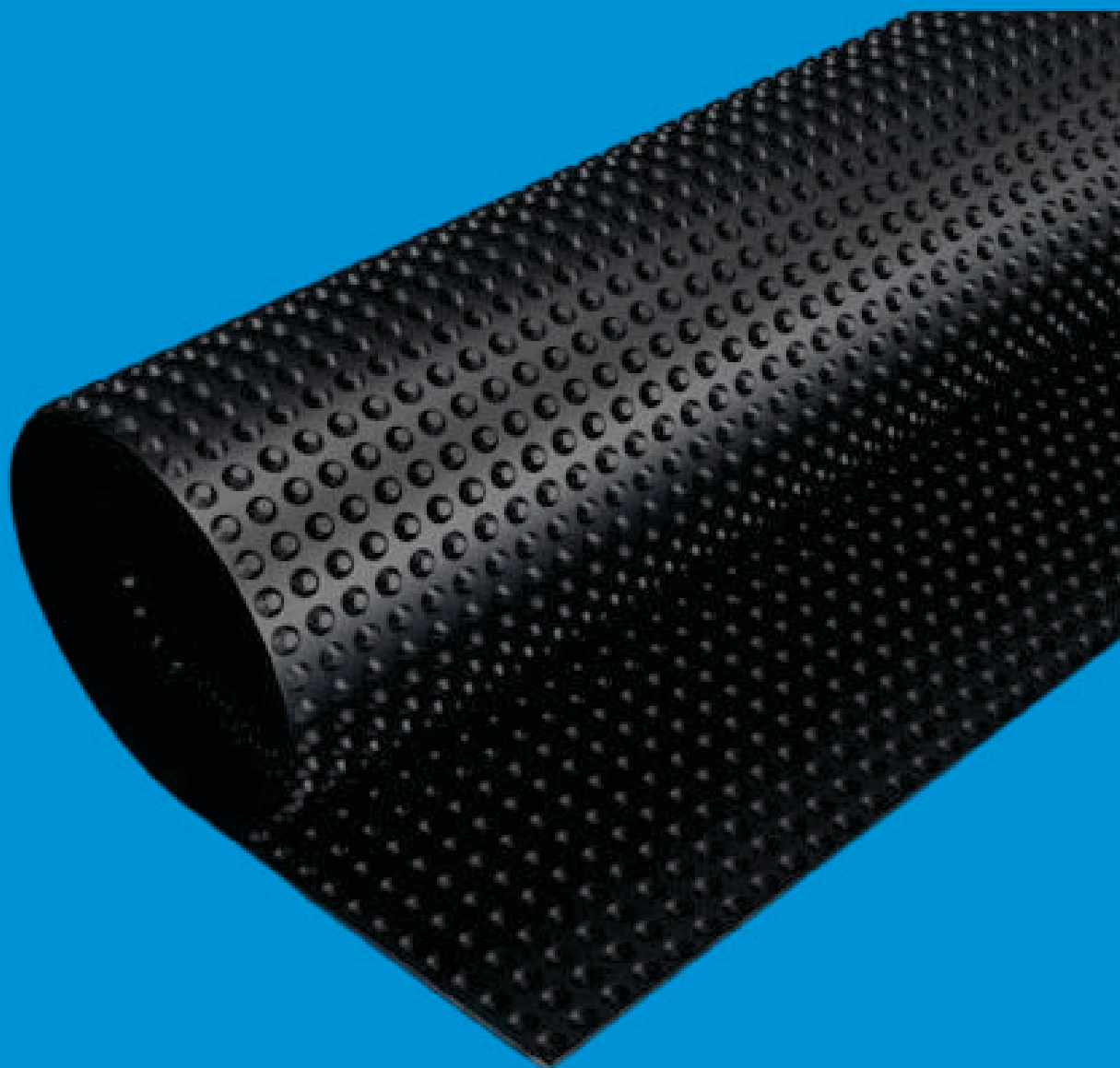



QAYNAQ AVADANLIQLARI  
WELDING MACHINES



Qaynaq edilən boruların diapazonu / Welded pipe range	ø 63 - ø 160 mm
Qaynaq edilən boruların təzyiqi / Welded pipe pressure	≤ ATM/PN 25
Çıxarılan əlavələr dəsti / A set of removable inserts	ø 40, 50, 63, 75, 90, 110, 125, 140 mm
Flans adapter / Flange adapter	ø 40 - ø 160 mm
Qaynaq edilmiş səthlərin emalı üçün elektirik keçiricili aparat / Trimmer with electric guards	220 V / 0,81 kWt
Qızdırıcı element / Heating element	220 V / 1,5 kWt
Generatorun summar gücü / Total generator power	2,3 kWt
Generatorun tələb olunan gücü / Required generator power	3,2 kWt
Çəki Netto / Net weight	81 kq / kg
Çəki Brutto / Gross weight	113 kq / kg
Daşınma yeşiyi: ölçülər / Transport box: Dimensions	600x1200x700 mm 0,5m <sup>3</sup>
İstehsalçı ölkə / Country of manufacture	Türkiyə / Turkey
Zəmanət / Warranty	12 ay / month

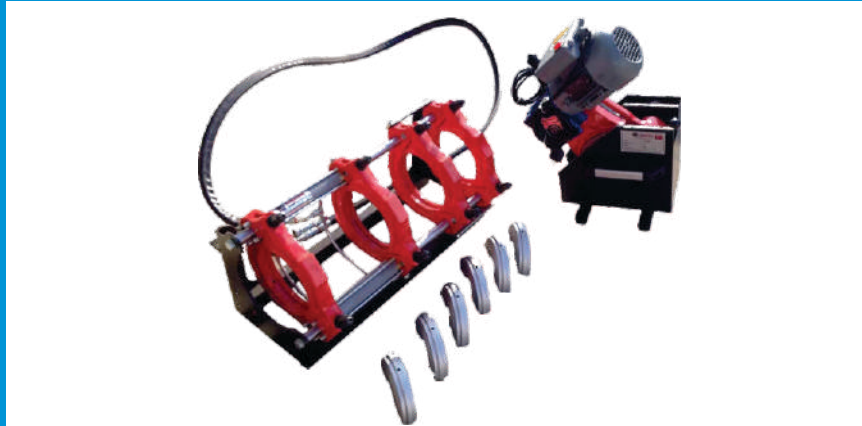

Qaynaq edilən boruların diapazonu / Welded pipe range	ø 75 - ø 250 mm	
Qaynaq edilən boruların təzyiqi / Welded pipe pressure	≤ ATM/PN 25	
Çıxarılan əlavələr dəsti / A set of removable inserts	ø 75, 90, 110, 125, 140, 160, 180, 200, 225, 250 mm	
Flans adapter / Flange adapter	ø 75 - ø 250 mm	
Qaynaq edilmiş səthlərin emalı üçün elektirik keçiricili aparat / Trimmer with electric guards	220V / 0,75 kWt	
Qızdırıcı element / Heating element	220V / 3,0 kWt	
İdarə bloklı hidroaparat / Hydraulic facility with control unit	220V / 5,5 kWt	
Hidrosistemin təzyiq diapazonu / Hydraulic system pressure range	0 - 140 bar	
Generatorun summar gücü / Total generator power	4,3 kWt	
Generatorun tələb olunan gücü / Required generator power	6,0 kWt	
Çəki Netto / Net weight	218 kq / kg	
Çəki Brutto / Gross weight	282 kq / kg	
Daşınma yeşiyi: ölçülər / Transport box: Dimensions	990x1340x700 mm, 1m <sup>3</sup>	
Ekranın displeyi / Screen Display	-	7" 65536 Colors TFT Screen DC24V
Dil menyusu / Language menu	-	Rus, Türk, İngilis / Russian, Turkish, English
Qaynaq standartları / Welding standard	-	DVS 2207-1
USB	-	var / have
Yaddaşın həcmi / Volume of memory	-	1000 izahat / explanation
İstehsalçı ölkə / Country of manufacture	Türkiyə / Turkey	
Zəmanət / Warranty	12 ay / month	



Qaynaq edilən boruların diapazonu / Welded pipe range	ø 90- ø 315 mm	
Qaynaq edilən boruların təzyiqi / Welded pipe pressure	≤ ATM/PN 25	
Çıxarılan əlavələr dəsti / A set of removable inserts	ø 90, 110, 125, 140, 160, 180, 200, 225, 250, 280 mm	
Flans adapter / Flange adapter	ø 90- ø 315 mm	
Qaynaq edilmiş səthlərin emalı üçün elektirik keçiricili aparat / Trimmer with electric guards	220 V / 0,75 kWt	
Qızdırıcı element / Heating element	220 V / 3,5 kWt	
İdarə bloklu hidroaparat / Hydraulic facility with control unit	220 V / 0,55 kWt	
Hidrosistemin təzyiq diapazonu / Hydraulic system pressure range	0 - 140 bar	
Generatorun summar gücü / Total generator power	4,8 kWt	
Generatorun tələb olunan gücü / Required generator power	6,7 kWt	
Çəki Netto / Net weight	271 kq / kg	
Çəki Brutto / Gross weight	346 kq / kg	
Daşınma yeşiyi: ölçülər / Transport box: Dimensions	1190x1240x980 mm, 1,5m <sup>3</sup>	
Ekranın displeyi / Screen Display	-	7" 65536 Colors TFT Screen DC24V
Dil menyusu / Language menu	-	Rus, Türk, İngilis / Russian, Turkish, English
Qaynaq standartları / Welding standard	-	DVS 2207-1
USB	-	var / have
Yaddaşın həcmi / Volume of memory	-	1000 izahat / explanation
İstehsalçı ölkə / Country of manufacture	Türkiyə / Turkey	
Zəmanət / Warranty	12 ay / month	



Qaynaq edilən boruların diapazonu / Welded pipe range	ø 160 - ø 400 mm	
Qaynaq edilən boruların təzyiqi / Welded pipe pressure	≤ ATM/PN 25	
Çıxarılan əlavələr dəsti / A set of removable inserts	ø 160, 180, 200, 225, 250, 280, 315, 355 mm	
Flans adapter / Flange adapter	ø 160 - ø 400 mm	
Qaynaq edilmiş səthlərin emalı üçün elektirik keçiricili aparat / Trimmer with electric guards	380 V / 1,1 kWt	
Qızdırıcı element / Heating element	380 V / 5,5 kWt	
İdarə bloklu hidroaparat / Hydraulic facility with control unit	380 V / 0,75 kWt	
Hidrosistemin təzyiq diapazonu / Hydraulic system pressure range	0 - 140 bar	
Generatorun summar gücü / Total generator power	7,35 kWt	
Generatorun tələb olunan gücü / Required generator power	10,0 kWt	
Çəki Netto / Net weight	400 kq / kg	
Çəki Brutto / Gross weight	490 kq / kg	
Daşınma yeşiyi: ölçülər / Transport box: Dimensions	1410x1550x1200 mm, 2,2 m <sup>3</sup>	
Ekranın displeyi / Screen Display	-	7" 65536 Colors TFT Screen DC24V
Dil menyusu / Language menu	-	Rus, Türk, İngilis / Russian, Turkish, English
Qaynaq standartları / Welding standard	-	DVS 2207-1
USB	-	var / have
Yaddaşın həcmi / Volume of memory	-	1000 izahat / explanation
İstehsalçı ölkə / Country of manufacture	Türkiyə / Turkey	
Zəmanət / Warranty	12 ay / month	



Qaynaq edilən boruların diapazonu / Welded pipe range	ø 180 - ø 500 mm	
Qaynaq edilən boruların təzyiqi / Welded pipe pressure	≤ ATM/PN 25	
Çıxarılan əlavələr dəsti / A set of removable inserts	ø 180, 200, 225, 250, 280, 315, 355, 400, 450 mm	
Flans adapter / Flange adapter	ø 180 - ø 500 mm	
Qaynaq edilmiş səthlərin emalı üçün elektirk keçiricili aparat / Trimmer with electric guards	380 V / 1,1 kWt	
Qızdırıcı element / Heating element	380 V / 5,5 kWt	
İdarə bloklu hidroaparat / Hydraulic facility with control unit	380 V / 0,75 kWt	
Hidrosistemin təzyiq diapazonu / Hydraulic system pressure range	0 - 140 bar	
Generatorun summar gücü / Total generator power	7,35 kWt	
Generatorun tələb olunan gücü / Required generator power	10,0 kWt	
Çəki Netto / Net weight	429 kq / kg	
Çəki Brutto / Gross weight	530 kq / kg	
Daşınma yeşiyi: ölçülər / Transport box: Dimensions	1430x1590x1200 mm, 2,7 m <sup>3</sup>	
Ekranın displeyi / Screen Display	-	7" 65536 Colors TFT Screen DC24V
Dil menyusu / Language menu	-	Rus, Türk, İngilis / Russian, Turkish, English
Qaynaq standartları / Welding standard	-	DVS 2207-1
USB	-	var / have
Yaddaşın həcmi / Volume of memory	-	1000 izahat / explanation
İstehsalçı ölkə / Country of manufacture	Türkiyə / Turkey	
Zəmanət / Warranty	12 ay / month	



Qaynaq edilən boruların diapazonu / Welded pipe range	ø 315 - ø 630 mm	
Qaynaq edilən boruların təzyiqi / Welded pipe pressure	≤ ATM/PN 25	
Çıxarılan əlavələr dəsti / A set of removable inserts	ø 315, 355, 400, 450, 500, 560 mm	
Flans adapter / Flange adapter	ø 315 - ø 630 mm	
Qaynaq edilmiş səthlərin emalı üçün elektirk keçiricili aparat / Trimmer with electric guards	380 V / 1,5 kWt	
Qızdırıcı element / Heating element	380 V / 7,5 kWt	
İdarə bloklu hidroaparat / Hydraulic facility with control unit	380 V / 0,75 kWt	
Hidrosistemin təzyiq diapazonu / Hydraulic system pressure range	0 - 140 bar	
Generatorun summar gücü / Total generator power	9,75 kWt	
Generatorun tələb olunan gücü / Required generator power	13,6 kWt	
Çəki Netto / Net weight	638 kq / kg	
Çəki Brutto / Gross weight	763 kq / kg	
Daşınma yeşiyi: ölçülər / Transport box: Dimensions	1330x1130x1300 mm, 1,95 m <sup>3</sup> & 1180x1150x1430 mm, 1,94 m <sup>3</sup>	
Ekranın displeyi / Screen Display	-	7" 65536 Colors TFT Screen DC24V
Dil menyusu / Language menu	-	Rus, Türk, İngilis / Russian, Turkish, English
Qaynaq standartları / Welding standard	-	DVS 2207-1
USB	-	var / have
Yaddaşın həcmi / Volume of memory	-	1000 izahat / explanation
İstehsalçı ölkə / Country of manufacture	Türkiyə / Turkey	
Zəmanət / Warranty	12 ay / month	



Qaynaq edilən boruların diapazonu / Welded pipe range	ø 500 - ø 800 mm	
Qaynaq edilən boruların təzyiqi / Welded pipe pressure	≤ ATM/PN 25	
Çıxarılan əlavələr dəsti / A set of removable inserts	ø 500, 560, 630, 710 mm	
Flans adapter / Flange adapter	ø 500 - ø 800 mm	
Qaynaq edilmiş səthlərin emalı üçün elektirk keçiricili aparat / Trimmer with electric guards	380 V / 2,2 kWt	
Qızdırıcı element / Heating element	380 V / 10,0 kWt	
İdarə bloklu hidroaparat / Hydraulic facility with control unit	380 V / 0,75 kWt	
Hidrosistemin təzyiq diapazonu / Hydraulic system pressure range	0 - 140 bar	
Generatorun summar gücü / Total generator power	13,0 kWt	
Generatorun tələb olunan gücü / Required generator power	18,0 kWt	
Çəki Netto / Net weight	935 kq / kg	
Çəki Brutto / Gross weight	1075 kq / kg	
Daşınma yeşiyi: ölçülər / Transport box: Dimensions	1240x1520x1340 mm, 2,5 m <sup>3</sup> & 1000x1600x1600 mm, 2,5 m <sup>3</sup>	
Ekranın displeyi / Screen Display	-	7" 65536 Colors TFT Screen DC24V
Dil menyusu / Language menu	-	Rus, Türk, İngilis / Russian, Turkish, English
Qaynaq standartları / Welding standard	-	DVS 2207-1
USB	-	var / have
Yaddaşın həcmi / Volume of memory	-	1000 izahat / explanation
İstehsalçı ölkə / Country of manufacture	Türkiyə / Turkey	
Zəmanət / Warranty	12 ay / month	



Qaynaq edilən boruların diapazonu / Welded pipe range	ø 630 - ø 1000 mm	
Qaynaq edilən boruların təzyiqi / Welded pipe pressure	≤ ATM/PN 25	
Çıxarılan əlavələr dəsti / A set of removable inserts	ø 630, 710, 800, 900 mm	
Flans adapter / Flange adapter	ø 630 - ø 1000 mm	
Qaynaq edilmiş səthlərin emalı üçün elektirk keçiricili aparat / Trimmer with electric guards	380 V / 3,0 kWt	
Qızdırıcı element / Heating element	380 V / 12,0 kWt	
İdarə bloklu hidroaparat / Hydraulic facility with control unit	380 V / 3,0 kWt	
Hidrosistemin təzyiq diapazonu / Hydraulic system pressure range	0 - 140 bar	
Generatorun summar gücü / Total generator power	18,0 kWt	
Generatorun tələb olunan gücü / Required generator power	25,0 kWt	
Çəki Netto / Net weight	2250 kq / kg	
Çəki Brutto / Gross weight	2260 kq / kg	
Daşınma yeşiyi: ölçülər / Transport box: Dimensions	1410x1550x1200 mm, 2,2 m <sup>3</sup>	
Ekranın displeyi / Screen Display	-	7" 65536 Colors TFT Screen DC24V
Dil menyusu / Language menu	-	Rus, Türk, İngilis / Russian, Turkish, English
Qaynaq standartları / Welding standard	-	DVS 2207-1
USB	-	var / have
Yaddaşın həcmi / Volume of memory	-	1000 izahat / explanation
İstehsalçı ölkə / Country of manufacture	Türkiyə / Turkey	
Zəmanət / Warranty	12 ay / month	



Qaynaq edilən boruların diapazonu / Welded pipe range	ø 710 - ø 1200 mm	
Qaynaq edilən boruların təzyiqi / Welded pipe pressure	≤ ATM/PN 25	
Çıxarılan əlavələr dəsti / A set of removable inserts	ø 710, 800, 900, 1000 mm	
Flans adapter / Flange adapter	ø 710 - ø 1200 mm	
Qaynaq edilmiş səthlərin emalı üçün elektirik keçiricili aparat / Trimmer with electric guards	380 V / 3,0 kWt	
Qızdırıcı element / Heating element	380 V / 16,0 kWt	
İdarə bloklu hidroaparat / Hydraulic facility with control unit	380 V / 2,2 kWt	
Hidrosistemin təzyiq diapazonu / Hydraulic system pressure range	0 - 160 bar	
Generatorun summar gücü / Total generator power	21,2 kWt	
Generatorun tələb olunan gücü / Required generator power	30,0 kWt	
Çəki Netto / Net weight	2550 kq / kg	
Çəki Brutto / Gross weight	2560 kq/kg	
Ekranın displeyi / Screen Display	-	7" 65536 Colors TFT Screen DC24V
Dil menyusu / Language menu	-	Rus, Türk, İngilis / Russian, Turkish, English
Qaynaq standartları / Welding standard	-	DVS 2207-1
USB	-	var / have
Yaddaşın həcmi / Volume of memory	-	1000 izahat / explanation
İstehsalçı ölkə / Country of manufacture	Türkiyə / Turkey	
Zəmanət / Warranty	12 ay / month	



TEKNIKİ XÜSUSİYYƏTLƏR / TECHNICAL FEATURES	
Qaynaq edilən boruların diapazonu/Welded pipe range	20-1200 mm
Çıxış Gərginliyi / Output Voltage	8-48 V
Normal Gərginlik / Nominal Voltage	230 V
Tezlik / Frequency	50/60 Hz
Güc / Power	2800 VA (80% dutry ey.)
Maks. Çıxış / Max. output current	120 A
İşləmə Temperaturu / Ambient Temperature	-20+60°C
Yaddaş / Memory	1800 qeyd (records)
Müdafiə Sınıfı / Protection class	IP54
Ölçülər / Dimensions	545x435x230
Ağırlıq / Weight	22 kg
Qaynaq Kabelinin Uzunluğu / Length of welding cable	4 m
Çalışma Rejimi / Operation mode	Barcode/Manuel



SIYİRTMƏ VƏ DEMONTAJ HİSSƏLƏRİ • YANĞIN VƏ SULAMA HİDRANLARI  
VALVES AND DISMANTLING PARTS • FIRE AND WATERING HYDRANTS

# SİYİRTMƏ VƏ DEMONTAJ HİSSƏLƏRİ • YANĞIN VƏ SULAMA HİDRANTLARI VALVES AND DISMANTLING PARTS • FIRE AND WATERING HYDRANTS

İKİLİ 2KS KLAPAN  
DUAL PLATECHECK VALVE



DN 50..350|PN 16

YERÜSTÜ V2 YERALTI YANĞIN HİDRANT  
OVERGROUND AND UNDERGROUND FIRE HYDRANT



DN 80-100|PN 16

QURU SİGNAL KLAPANI  
WET ALARM VALVE



DN 100...200 300 PSİ (20,6 Bar)

SULU SİGNAL KLAPANI  
DRY ALARM VALVE



DN 65...200 300 PSİ (20,6 Bar)

C2R2YAN AÇARI  
FLOW SWITCH



1"..8"

S TIPLİ C2R2YAN SAYĞACI  
S TYPE FLOÜMETR



2 1/2"..8"

YANĞIN SPRİNKLERİ  
FİRE SPRINKLERS



1/2" NPT, 3/4" NPT

SPRİNKLER ROZETİ  
SPRINKLER ESCUTCHEON



1/2" NP v-B 3/4" NPT

SPRİNKLER BAĞLANTI XORTUMU  
SPRINKLER CONNECTION HOSES



1/2" v-B 3/4" 275 PSİ (25 Bar)

İKİLİ GİRİ KLİ YANĞINSÖNDÜR2N  
FIRE FIGHTING 2



4x 2 1/2" x 2 1/2"

ENİ KLİ SİYİRTM2  
LANDING VALVE



2 1/2" x 2 1/2"

DİNAMİK TARAZLAYICI SİYİRTM2  
DYNAMIC BALANCING VALVE



1/2"..2"| PN 25

STATİK TARAZLAYICI SİYİRTMƏ  
STATİK BALANCİNG VALVE



STATİK TARAZLAYICI SİYİRTMƏ  
STATİK BALANCİNG VALVE



DARTMA TİPLİ KÜRƏLİ SİYİRTMƏ  
LUG TYPE BALL VALVE



KÜRƏLİ SİYİRTMƏ  
BALL VALVE



FLYANSLI PASLANMAYAN KÜRƏLİ SİYİRTMƏ  
FLANGED STAINLESS STEEL VALVE



ELASTİK FLYANSLI F4 SİYİRTMƏ  
F4 RESILIENT GATE VALVE



ELASTİK FLYANSLI F5 SİYİRTMƏ  
F5 RESILIENT SEATED GATE VALVE



KƏPƏNƏKVARI SİYİRTMƏ  
WAFER BUTERFLY VALVE



KƏPƏNƏKVARI SİYİRTMƏ  
WAFER BUTTERFLY VALVE



NİKEL ƏSASLI SİYİRTMƏ  
NICKEL PLATED LUG VALVE



PASLANMAZ METAL SİYİRTMƏ  
STAINLESS STEEL LUG VALVE



KƏPƏNƏKVARI SİYİRTMƏ ÜÇÜN SÜRƏT QUTUSU  
GEAR BOX BUTERFLY VALVE



# SİYİRTMƏ VƏ DEMONTAJ HİSSƏLƏRİ • YANĞIN VƏ SULAMA HİDRANTLARI VALVES AND DISMANTLING PARTS • FIRE AND WATERING HYDRANTS

İKİLİ FLYANSLI KƏPƏNƏKVARI SİYİRTMƏ  
DOUBLE FLANGED BUTTERFLY VALVE



DN 80..2000

DEMONTAJ PARÇASI  
DISMANTLING JOINT



DN 40..2000

TƏRS ÇEVİRİLİ BUXAR KLAPANI  
INVERTED BUCKET STEAM TRAP



DN 15..50

ƏYİLƏN ƏKS KLAPAN  
TILING CHECK VALVE



DN 250..1000

QORUYUCU SİYİRTMƏ  
SAFETY VALVE



DN 25..100

DARTMA KƏPƏNƏKVARI SİYİRTMƏ  
LUG BUTTERFLY VALVE



DN 15..300

BUŞAKLE DƏSTİ  
SURFACE BOX



DN 40..400

İKİLİ DİSK TİPLİ ƏKS KLAPAN  
WAFER DUAL PLATE CHECK VALVE



DN 50..600

FLYANSLI ƏKS KLAPAN  
SWIG CHECK VALVE



DN 40..350

DİSK TİPLİ ƏKS KLAPAN  
WAFER DISC CHECK VALVE



DN 15..200

DÜZ SÜZGƏC  
STRAIGHT TYPE STRAINER



DN 65..400

Y TİPLİ SÜZGƏC  
Y TYPE STRAINER



DN 15..800

ƏYİLMƏ ƏKS KLAPAN  
TILTING CHECK VALVE



DN 40..300

REZİNLİ KOMPENSATOR  
RUBBER EXPANSION JOINT



DN 25..600

GENİŞ HAVALI METAL BİRLƏŞMƏ  
METAL BELLOWS EXPANSION JOINT



DN 25..250

METAL ƏSASLI KOMPENSATOR  
METAL BELLOWS EXPANSION JOINT



DN 25..00

KÜRƏ SİYİRTMƏ  
BRASS BALL VALVE



1/2" ..2"

YAYLI TUNC ƏKS KLAPAN  
BRASS CHECK VALVE WITH SPRING



1/2" ..4"

TUNC Y TIPLİ SÜZGƏC  
BRASS Y TYPE STRAINER



1/2" ..3"

AVTOMATİK HAVA VENTİL  
AUTOMATIC AIR VENT



1/2"

YERALTI HİDRANT QAZANI  
HYDRANT UNDERGROUND BOILER



ZƏRBƏYƏ DAVAMLİ KİNETİK VANTUS  
UNINTERRUPTED KINETIC VALVE



TOPLU ƏKS KLAPAN  
CHECK VALV BALL

CEKVARF (toplu)



SUVARMA ÜÇÜN SİYİRTMƏ  
RECEIVER

TARIMSAR SULAMA  
(ALMAÇ)







# NASOS VƏ NASOS SİSTEMLƏRİ PUMP AND PUMP SYSTEMS

## NASOS VƏ NASOS SİSTEMLƏRİ PUMP AND PUMP SYSTEMS



### Tullantı suları üzrə dalma nasoslar Submersible Sewage Pumps

Basma həcmi Capacity	3400 m <sup>3</sup> /ha
Basma hündürlüyü Head	90 m
Mühərrikin sürəti Speed	2900 ddəq/rpm
Maye temperaturu Operating Temperature	-10°C+40°C
Gövdə təzyiqi (Pmaks) Casing Pressure (Pmaks)	10 bar



### Tək mərhələli monoblok mərkəzdənqaçma nasosları Single Stage Close Coupled Centrifugal Pumps

Basma həcmi Capacity	500 m <sup>3</sup> /ha
Basma hündürlüyü Head	95 m
Mühərrikin sürəti Speed	2900 ddəq/rpm
Maye temperaturu Operating Temperature	-10°C+110°C
Gövdə təzyiqi (Pmaks) Casing Pressure (Pmaks)	10 bar (15 bar)



### Dövriyyə nasosları In-Line Centrifugal Pumps

Basma həcmi Capacity	500 m <sup>3</sup> /ha
Basma hündürlüyü Head	100 m
Mühərrikin sürəti Speed	2900 ddəq/rpm
Maye temperaturu Operating Temperature	-10°C+110°C
Gövdə təzyiqi (Pmaks) Casing Pressure (Pmaks)	10 bar (16 bar)
Güc Power	90 kWt

## NASOS VƏ NASOS SİSTEMLƏRİ PUMP AND PUMP SYSTEMS



### Hidrofor nasos sistemləri Booster Pumps

Basma həcmi Capacity	153 m <sup>3</sup> /ha
Basma hündürlüyü Head	150 m
Mühərrikin sürəti Speed	2900 ddəq/rpm
Maye temperaturu Operating Temperature	-10°C+160°C
Gövdə təzyiqi (Pmaks) Casing Pressure (Pmaks)	16 bar



### Hidrofor nasos sistemləri Booster Pumps

Basma həcmi Capacity	45 m <sup>3</sup> /ha
Basma hündürlüyü Head	130 m
Mühərrikin sürəti Speed	2900 ddəq/rpm
Maye temperaturu Operating Temperature	-0°C+60°C
Gövdə təzyiqi (Pmaks) Casing Pressure (Pmaks)	16 bar



### Paslanmaz hidrofor nasos sistemləri Stainless Steel Booster Pumps

Basma həcmi Capacity	20 m <sup>3</sup> /ha
Basma hündürlüyü Head	16 bar
Mühərrikin sürəti Speed	2900 ddəq/rpm
Maye temperaturu Operating Temperature	-10°C+90°C
Gövdə təzyiqi (Pmaks) Casing Pressure (Pmaks)	16 bar

## NASOS VƏ NASOS SİSTEMLƏRİ PUMP AND PUMP SYSTEMS



### Dalma nasoslar Submersible pumps

Basma həcmi Capacity	24 m <sup>3</sup> /ha
Basma hündürlüyü Head	300 m
Mühərrikin sürəti Speed	2900 ddəq/rpm
Maye temperaturu Operating Temperature	-10°C+40°C



### Paslanmaz Polad dalma nasoslar Stainless Steel Submersible Pumps

Basma həcmi Capacity	270 m <sup>3</sup> /ha
Basma hündürlüyü Head	450 m
Mühərrikin sürəti Speed	2900 ddəq/rpm
Maye temperaturu Operating Temperature	-10°C+40°C

# YANĞIN NASOS SİSTEMLƏRİ FIRE PUMP SYSTEMS

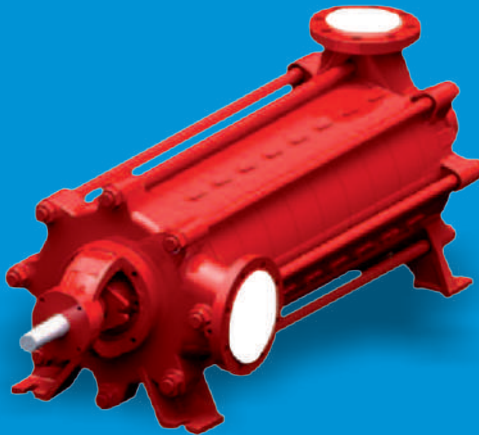





# QUYU QAPAQLARI VƏ DRENAJ SİSTEMLƏRİ MANHOLE COVERS AND DRAINAGE SYSTEMS

# QUYU QAPAQLARI / MANHOLE COVERS

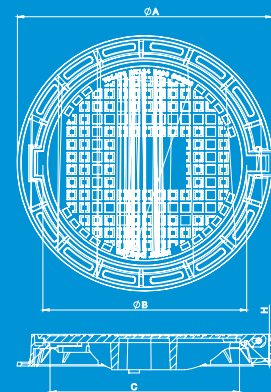
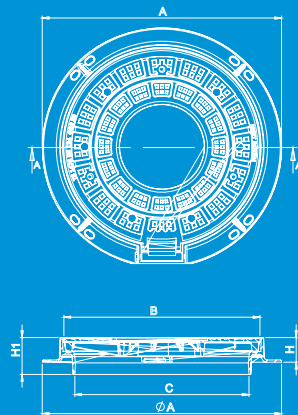
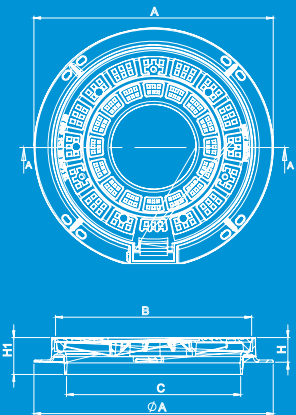

CODE KOD	ØA	ØB	ØC	H	Kg
M121	810	665	605	90/130	72±3
M121	810	665	605	90/130	88±3
M122	810	665	605	90/130	72±3
M122	810	665	605	90/130	88±3

CODE KOD	ØA	ØB	ØC	H	Kg
M106	810	665	605	90/130	88±3

CODE KOD	ØA	ØB	ØC	H	Kg
M186E	810	660	600	100	81±3
M186E	810	660	600	140	85±3

# QUYU QAPAQLARI / MANHOLE COVERS

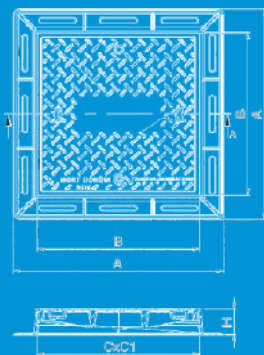
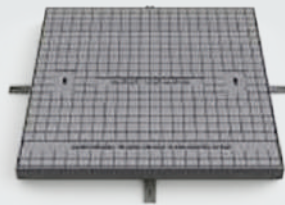

CODE KOD	AxA1	BxB1	CxC1	H	Kg
M172	790x790	610x610	600x550	100	83±3

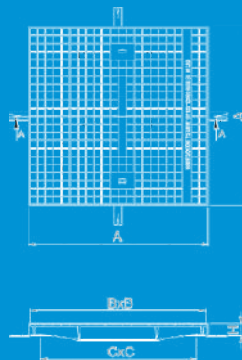

CODE KOD	AxA1	BxB1	CxC1	H	Kg
M183	920x920	900x900	800x800	60	125±3

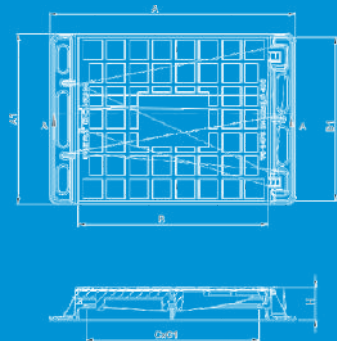

CODE KOD	AxA1	BxB1	CxC1	H	Kg
M1105	745	560	525	100	62±3

# DRENAJ SİSTEMLƏRİ / DRAINAGE SYSTEMS

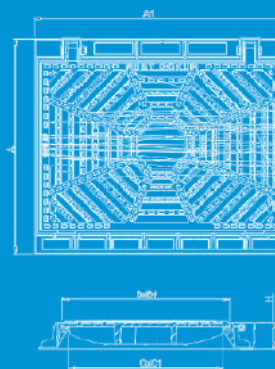
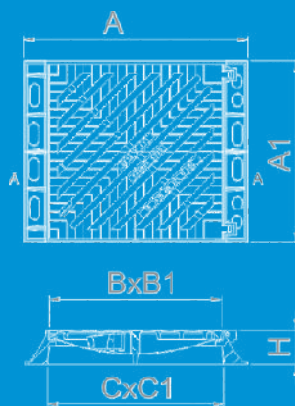
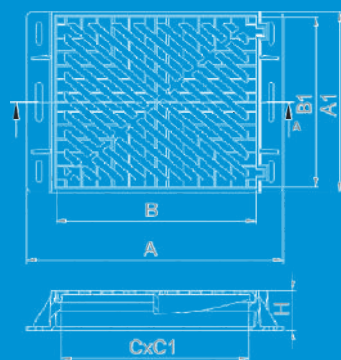
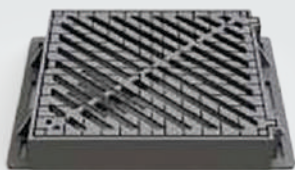
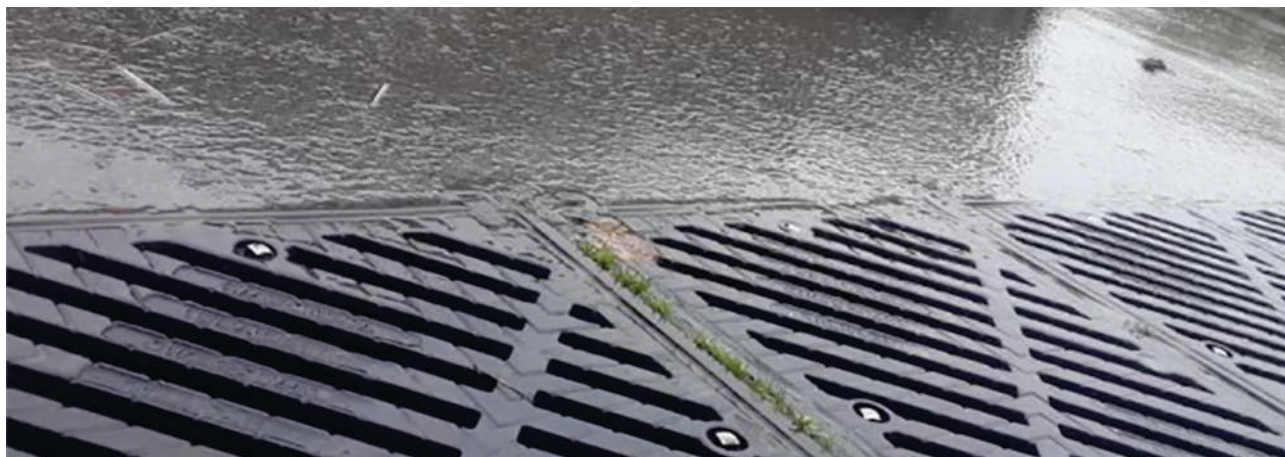

CODE KOD	AxA1	BxB1	CxC1	H	Kg
M110	740x515	560x490	520x450	100	60±3

CODE KOD	AxA1	BxB1	CxC1	H	Kg
M113	740x600	600x600	520x520	115	74±3
M1113	740x600	600x600	520x520	115	85±3

CODE KOD	AxA1	BxB1	CxC1	H	Kg
M1115	912x775	874x611	825x562	98	96±3
M1115	912x775	874x611	825x562	120	118±3

# DRENAJ SİSTEMLƏRİ / DRAINAGE SYSTEMS

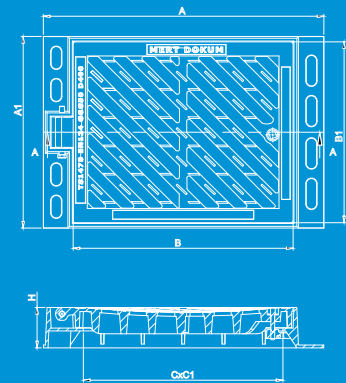
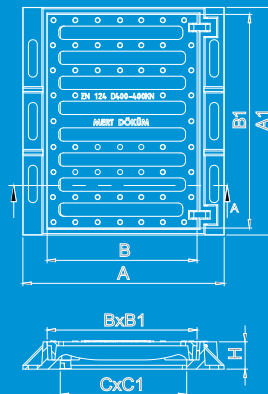
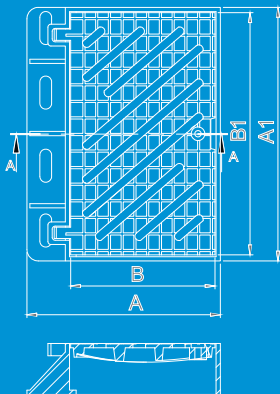
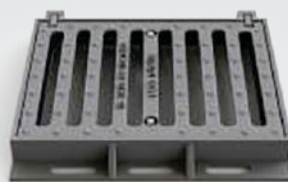
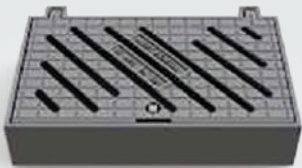

CODE KOD	AxA1	BxB1	CxC1	H	Kg
M162	445x605	340x565	290x560	110	45±2

CODE KOD	AxA1	BxB1	CxC1	H	Kg
M160	635x720	475x675	400x600	85	80±3

CODE KOD	AxA1	BxB1	CxC1	H	Kg
M120	640x470	540x440	485x380	55	60±3

# DRENAJ SİSTEMLƏRİ / DRAINAGE SYSTEMS



CODE KOD	A	B	H	Kg	CODE KOD	A	B	H	Kg	Berklik Strenght
M125/S60	125	1000	60	8 ± 2	M130A	125	500	20	4 ± 1	B 125
M125/S80	125	1000	80	9 ± 2						
M125/S80A	125	500	80	4,5 ± 2						
M125/S60A	125	500	60	4,5 ± 2						
M125/110	125	1000	110	10,5 ± 2						
M125/110A	125	500	110	5 ± 2						
M125/01	125	1000	150	14 ± 3						
M125/01A	125	500	150	6 ± 2						
M125/170	125	1000	170	12 ± 2						
M125/170A	125	500	170	7,5 ± 2						
M125/02	125	1000	200	16 ± 2						
M125/02A	125	500	200	7 ± 2						
M200/S	200	1000	80	10,5 ± 2	M132DK	200	500	35	8,5 ± 2	C 250
M200/SA	200	500	80	5,5 ± 2						
M200/130	200	1000	130	15 ± 2						
M200/130A	200	500	130	7,5 ± 2						
M200/250	200	1000	250	22 ± 2						
M200/250A	200	500	250	12,5 ± 2						
M200/01	200	1000	195	20 ± 1						
M200/01A	200	500	195	9 ± 2						
M200/F1	220	1000	280	24 ± 2	M200/F2	200	500	20	14 ± 2	E 600
M300/S	300	1000	80	20 ± 3	M134DK	300	500	27	14 ± 2	D 400
M300/SA	300	500	80	10 ± 2						
M300/3S	300	1000	140	22,5 ± 3						
M300/3SA	300	500	140	12 ± 3						
M300/4S	300	1000	200	21 ± 3						
M300/4SA	300	500	200	12,5 ± 2						
M300/01	300	1000	250	38 ± 2						
M300/01A	300	500	250	17 ± 2						
M300/02S	300	1000	80	25 ± 2						
M350/F1	375	1000	410	66 ± 3						
M400/S	400	1000	110	25 ± 3	M135A				16 ± 2	D 400
M400/03	400	1000	300	45 ± 3						
M400/03A	400	500	300	21 ± 3						
M400/01	400	1000	400	58 ± 3						
M400/01A	400	500	400	28,5 ± 3						

# DRENAJ SİSTEMLƏRİ / DRAINAGE SYSTEMS

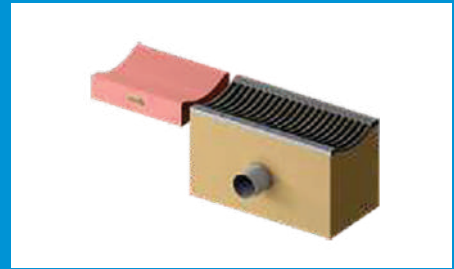
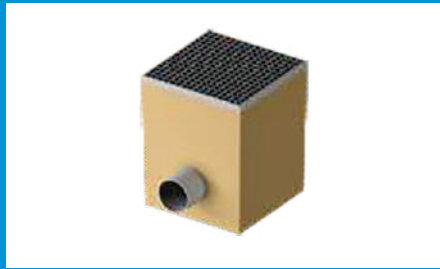
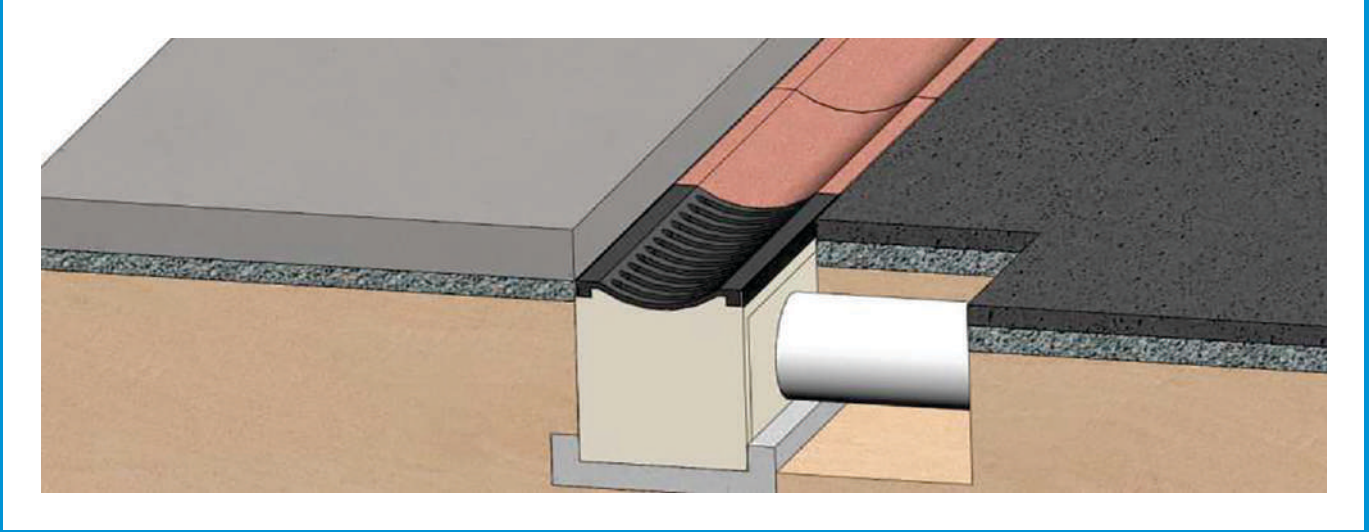

51±2 A 15 B 125 C 250

CODE KOD	A	B	Pipe Out Boru Çıkış	H	Kg
M380	500	260	DN 100	600	51±2

41±2 A 15 B 125 C 250

CODE KOD	A	B	Pipe Out Boru Çıkış	H	Kg
M381	325	325	DN 100	400	41±2
M383	325	325	DN 100	500	56±2

38±2 A 15 B 125 C 250

CODE KOD	A	B	Pipe Out Boru Çıkış	H	Kg
M382	600	300	DN 100	700/32	38±2

# DRENAJ SİSTEMLƏRİ / DRAINAGE SYSTEMS

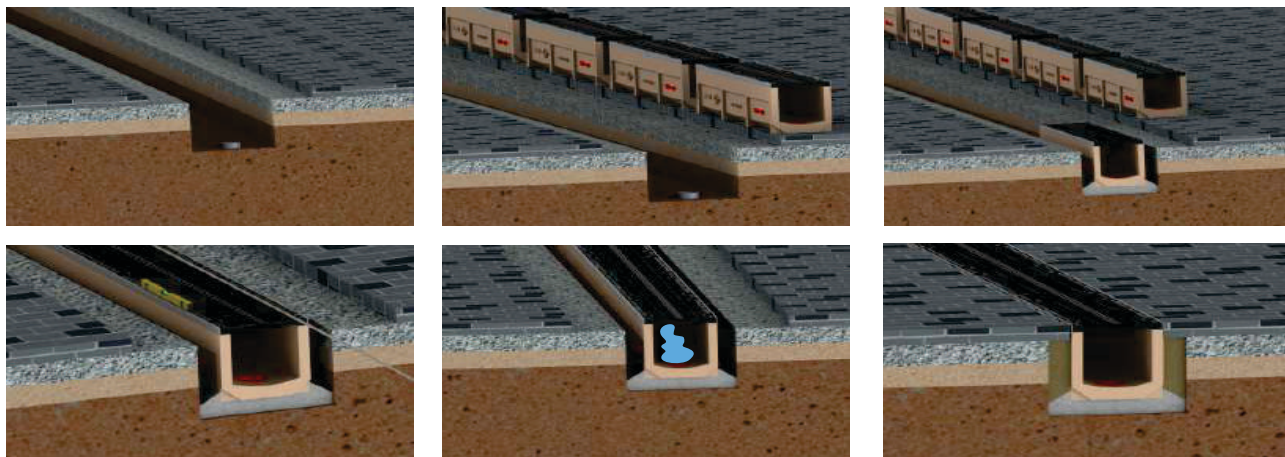

## PLASTIC SAYĞAC QUTUSU PLASTIC COUNTER BOX

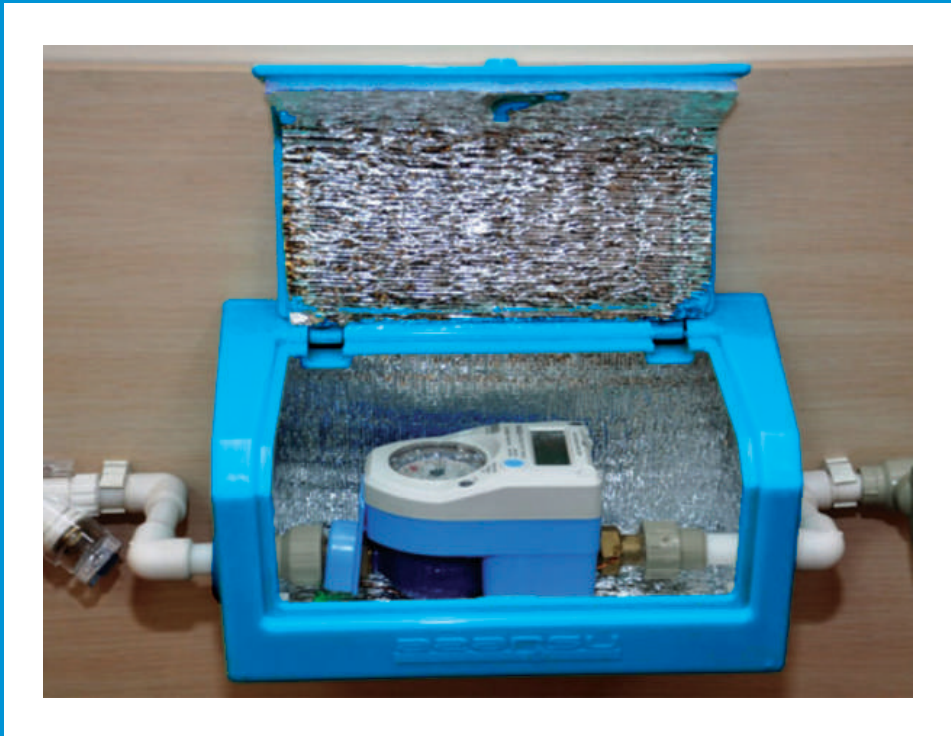

# MÜXTƏLİF NÖV MƏHSULLARIN DAŞINMASI VƏ SAXLANILMASI ÜÇÜN PLASTİK YEŞİKLƏR PLASTIC BOXES FOR TRANSPORTATION AND STORAGE OF VARIOUS TYPES OF PRODUCTS



590x400x140 mm  
çəkisi/weight - 1.09 kq  
yükgötürmə qabiliyyəti/shipping capacity 10-12 kq



590x400x210 mm  
çəkisi/weight - 1.45 kq  
yükgötürmə qabiliyyəti/shipping capacity 18-20 kq



750x470x260 mm  
çəkisi/weight - 2.5 kq  
yükgötürmə qabiliyyəti/shipping capacity 20-25 kq



600x400x180 mm  
çəkisi/weight - 2.4 kq  
yükgötürmə qabiliyyəti/shipping capacity 15-18 kq



590x400x180mm  
çəkisi/weight - 1.25 kq  
yükgötürmə qabiliyyəti/shipping capacity 13-17 kq



600x400x250 mm  
çəkisi/weight - 3 kq  
yükgötürmə qabiliyyəti/shipping capacity 22-25 kq

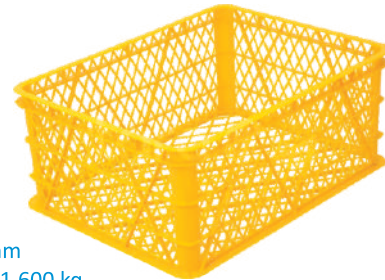

600x400x260mm  
çəkisi/weight - 1.600 kq  
yükgötürmə qabiliyyəti/shipping capacity 20-25 kq



610x420x130mm  
çəkisi/weight - 1.35 kq  
yükgötürmə qabiliyyəti/shipping capacity 12-15 kq



630x420x140mm  
çəkisi/weight - 1.38 kq  
yükgötürmə qabiliyyəti/shipping capacity 15-17 kq



TƏMİR XAMUTLARI  
REPAIR COUPLINGS

# MÜXTƏLİF ÖLÇÜLÜ BORU XAMUTLARI

## DIFFERENT SIZE PIPE COUPLING



Kəşik / Cut view  
DN 88,9-4000



Xamut / Coupling

Ölçü / Body width: 210 mm

## XAMUT-MUFTA / COUPLING-CLAMPS



Standart Tip  
Standard Type



Siyirtməli Tip  
Service Valve Type

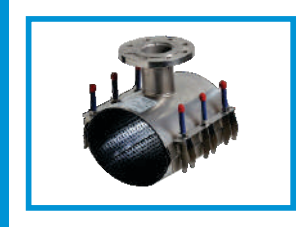

Flyanslı Tip  
Wafer Clamp Type  
DN 76,1-1000

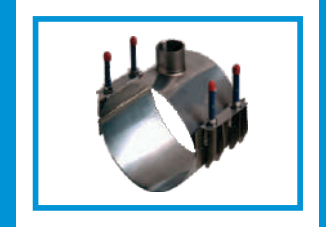

Səmərli Tip  
Saddle Clamp Type

## BORU ADAPTER / PIPE ADAPTOR



Universal Polad Tip  
Steel Body Universal Type

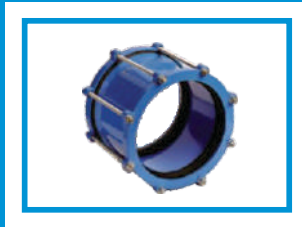

Böyük Ölçülü Polad Tip  
Steel Body Large Type  
Ø 90-2500 mm



Polad Adapter  
Steel Body Reduction  
Ø 90-2500 mm

## XAMUT / COUPLING

DN25-600



DN70-600

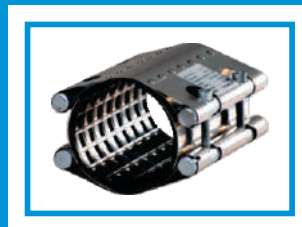

DN 20-23

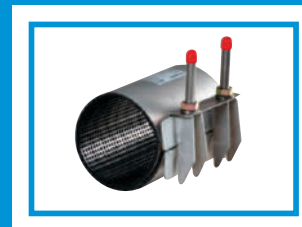

DN 510-530

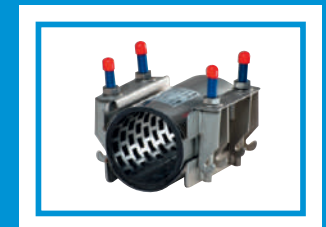

## XAMUT / COUPLING

DN50-200



DN25-4000

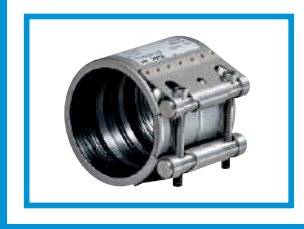

DN25-4000



## HDPE MUFTA / HDPE CLAMP



DN: 100-1800 mm  
ATM / PN: 16-6

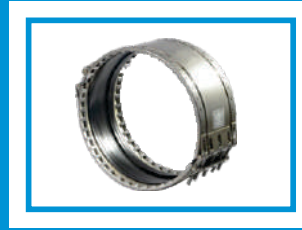

DN 63-1600

## HAVA TEST BALONLARI / PNEUMATIC PLUG



Ø 40-1800 mm



## BORULARIN DAXİLDƏN TƏMİR SİSTEMİ / PIPE INSIDE REPAIR SYSTEM

DN500-DN4000



Ölçü / Body width: 210 mm

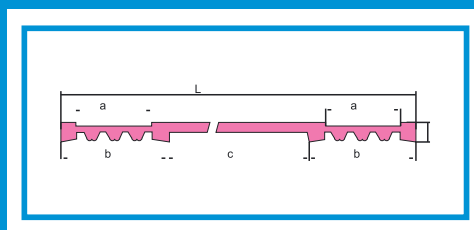

Kəsik ölçü 420 mm

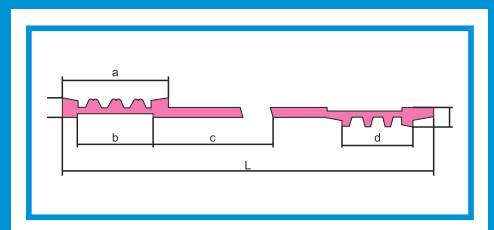

Kəsik ölçü 465 mm

# MONTAJ / INSTALLATION





# SUVARMA SİSTEMLƏRİ IRRIGATION SYSTEMS

# SUVARMA SİSTEMLƏRİ / IRRIGATION SYSTEMS

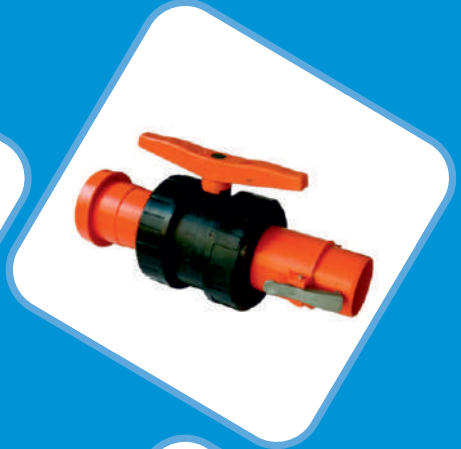

# SUVARMA SİSTEMLƏRİ / IRRIGATION SYSTEMS





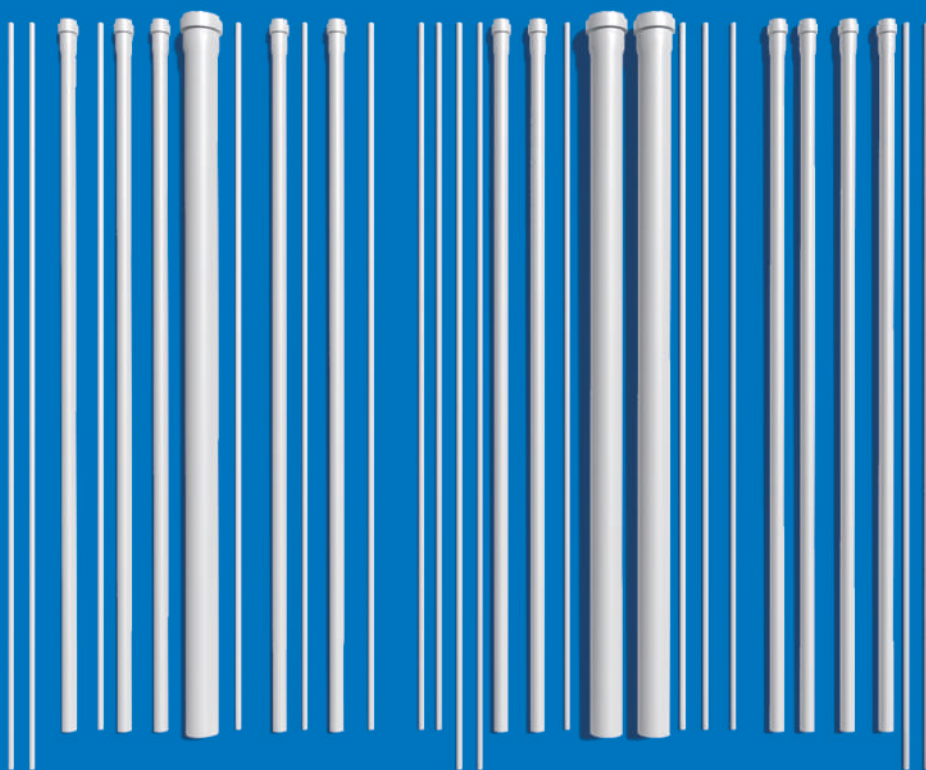

TIVI Plaza, 1, Ahmad Rajabli str., Baku, Azerbaijan, AZ1075  
AZ1075, Bakı, Azərbaycan, Əhməd Rəcəbli küç., 1 TIVI Plaza

+994 12 464 83 70  
+994 51 788 88 33  
office@polymart.az  
www.polymart.az